

Quick Installation Guide

1. RXV200 Introduction

Thank you for purchasing AudioCodes **RXV200 Microsoft Teams Rooms on Android Compute Unit**! This guide shows how to quickly install RXV200. AudioCodes has created a range of Microsoft Teams Rooms bundles based on the RXV200 compute unit and RX-PAD Meeting Room Controller.

RXV200 connects multiple audio and video peripherals, as well as dual screens, and offers support for a wide range of AI capabilities. RX-PAD allows users to seamlessly orchestrate productive meeting experiences.

AudioCodes offers three comprehensive RXV200 bundles:

- ✓ **RXV200-B05 – for adding Teams to existing rooms**
RXV200 + RX-PAD connecting to 3rd party equipment.
- ✓ **RXV200-B20 - for small-to-medium rooms with 4-10 participants**
RXV200 + RX-PAD + RXVCAM50M + RX15 (small/medium room)
- ✓ **RXV200-B40 - ideal for large rooms with 10-16 participants**
RXV200 + RX-PAD + RXVCAM50M + RX40 (large room)

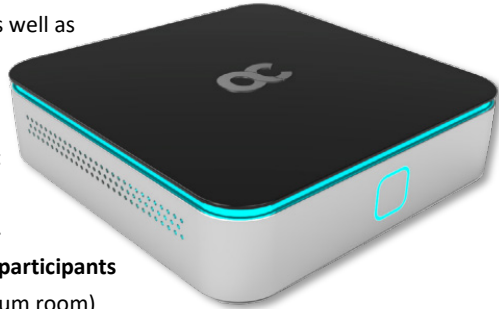

2. Package Contents

Make sure you received the following items in the shipped box:

RXV200-B05

- ✓ RXV200
- ✓ RX-PAD Meeting Room Controller
- ✓ 12V 3A Power Adapter (100-240V)
- ✓ Ethernet cable

RXV200-B20

- ✓ RXV200
- ✓ RX15 Speakerphone (2.5m pickup radius)
- ✓ RX-PAD Meeting Room Controller
- ✓ RXVCam50 4K Video Conference Camera
- ✓ 12V 3A Power Adapter (100-240V)
- ✓ USB Type C cable
- ✓ Ethernet cable

RXV200-B40

- ✓ RXV200
- ✓ RX40 Soundbar and Satellite Mics (8m pickup radius)
- ✓ RX-PAD Meeting Room Controller
- ✓ RXVCam50 4K Video Conference Camera
- ✓ 12V 3A Power Adapter (100-240V)
- ✓ USB Type C cable
- ✓ Ethernet cable

3. Configuring a Bundle

Customers will receive the RXV200 with the ordered bundle preconfigured. This section shows how to change the preconfigured bundle to another.

To change the preconfigured bundle:

1. Open the Bundle page on the RXV200 (**Settings > Bundle**).

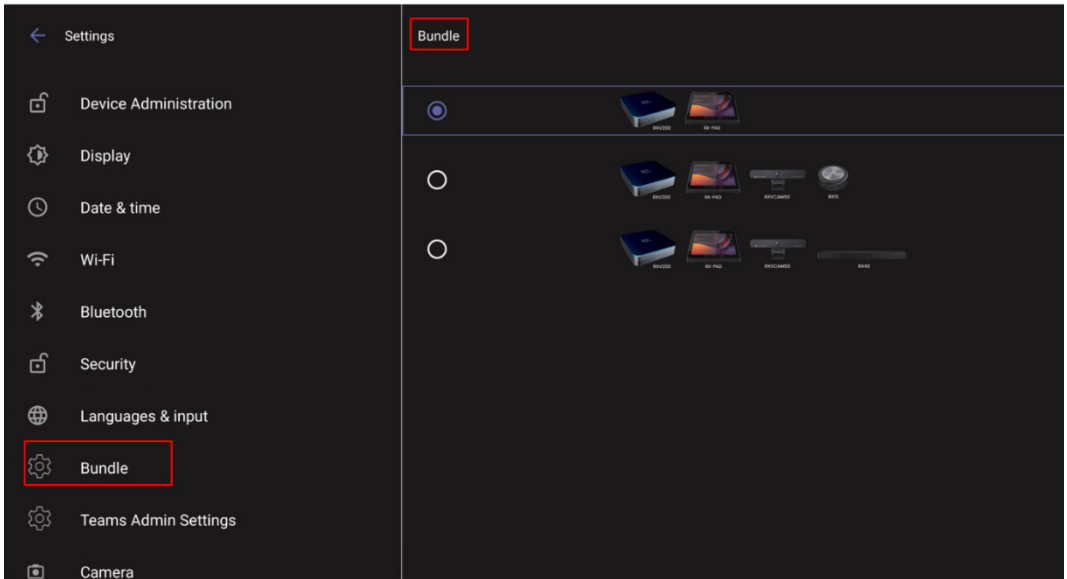

2. The preceding figure shows RXV200 + RX-PAD as the selected bundle. See the preceding sections for more information about available bundles.

4. RXV200 Interface

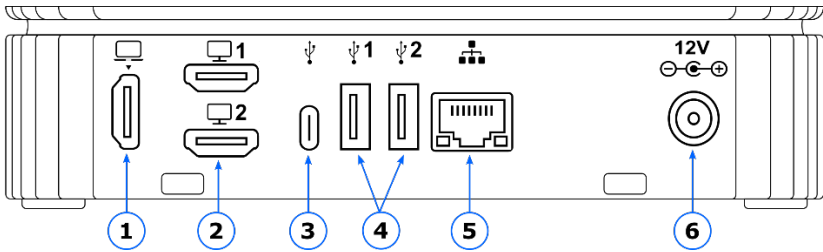

#	Port	Description
1	HDMI Input types	HDMI 2.0 Input (including audio)
2	HDMI Outputs	2 x HDMI 1.4 Outputs to external screens
3	USB-C	Connects camera, audio peripherals
4	USB-A (x2)	Connects camera, audio peripherals
5	LAN RJ-45	Connects RXV200 to the network
6	DC IN 12V 3A	Connects to 12V adapter

5. Connection Diagram

Connection Diagram for RXV200-B05

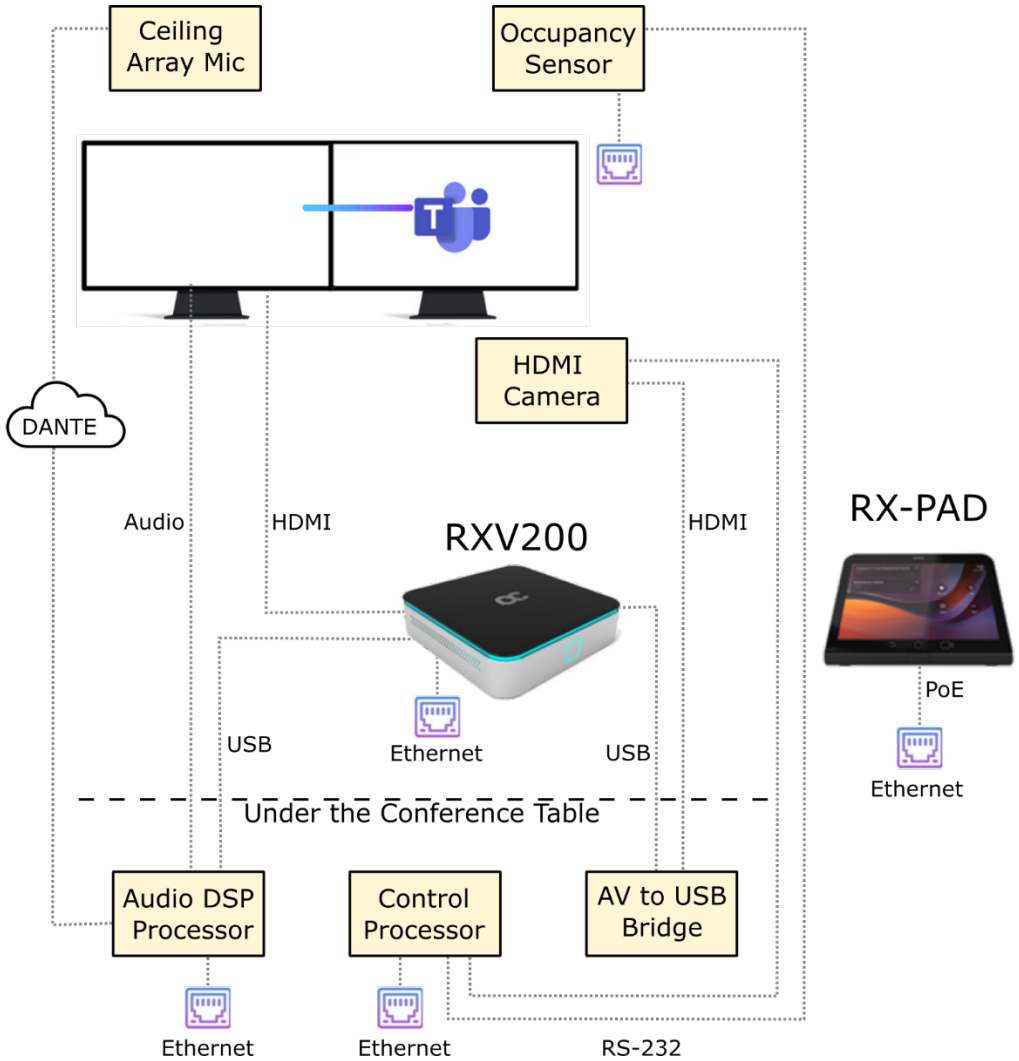

Connection Diagram for RXV200-B40

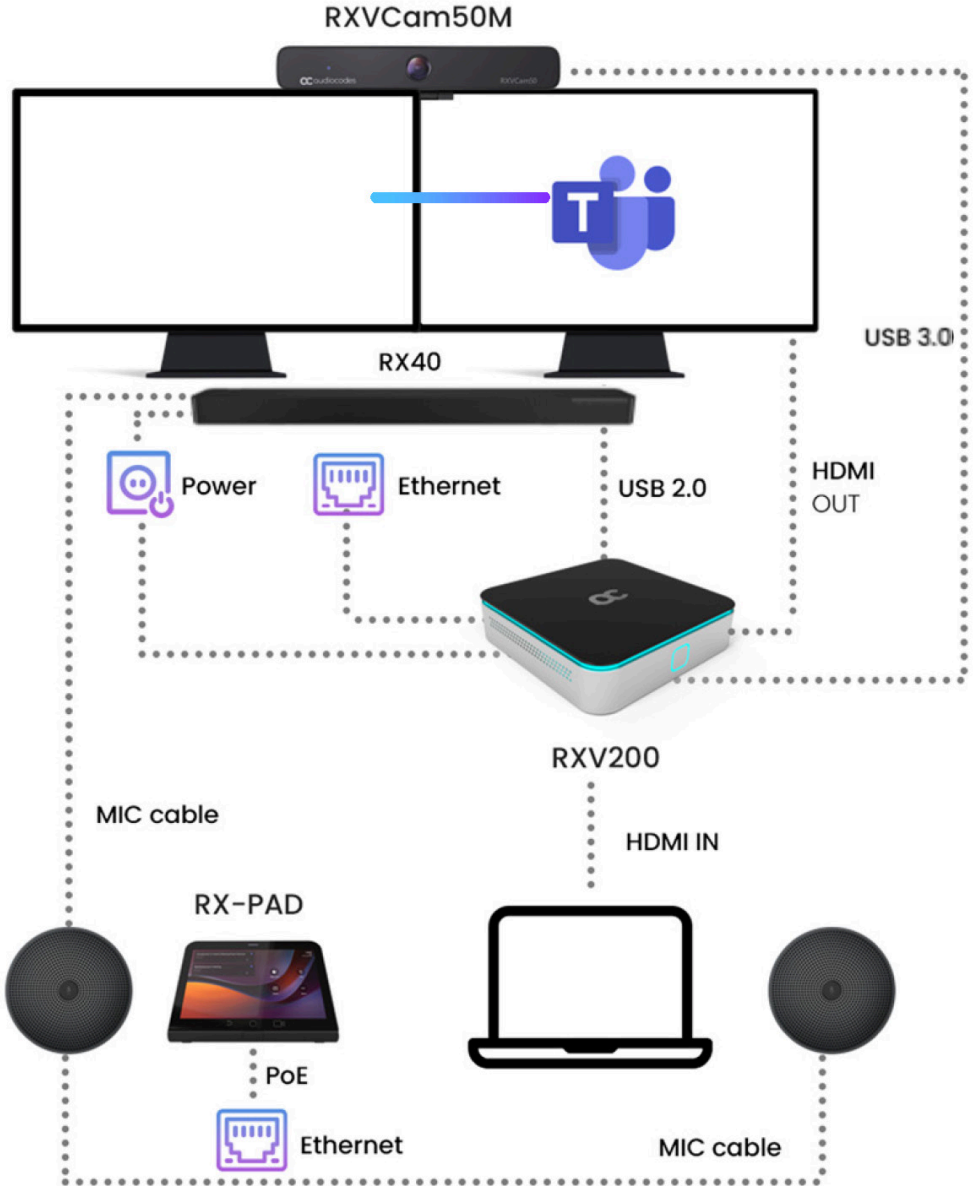

RX40 Speaker Setup in Section 6

6. Pairing RX-PAD with RXV200

To pair RX-PAD with RXV200, see [here](#).



- **When pairing RX-PAD with RXV200 over an ETH connection:**
 - The RXV-Pair process is for initial Bluetooth pairing.
 - After pairing, RX-PAD's admin password and additional settings from RX-PAD are inherited to RXV200.
- **When pairing RX-PAD with RXV200 over a Wi-Fi connection:**
 - Before pairing, use a USB mouse connected to RXV200 to enable Wi-Fi (Settings > Wi-Fi). **Using a USB mouse is mandatory when establishing a Wi-Fi setup.**
 - After that, *always* use RX-PAD's Remote Keyboard function.
 - After pairing, RX-PAD admin password and additional settings from RX-PAD are inherited to RXV200.

7. RX40 Speaker Connection Diagram for RVX200-B40

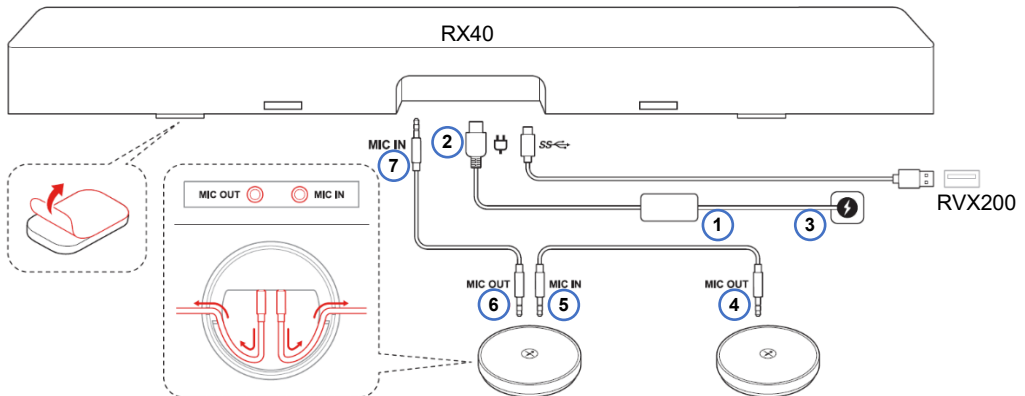

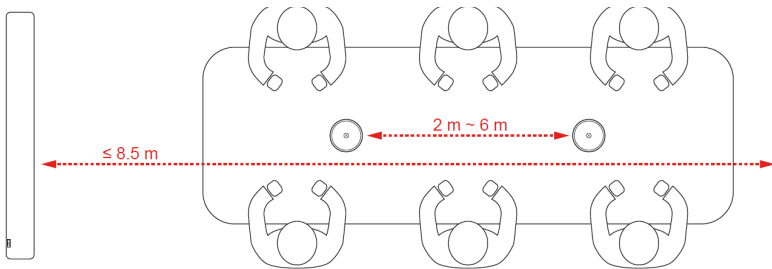

8. Technical Specifications

For RXV200 technical specification, please refer to the [RXV200 Datasheet](#).

International Headquarters

Naimi Park
Ofra Haza 6
Or Yehuda, Israel
Tel: +972-3-976-4000
Fax: +972-3-976-4040

AudioCodes Inc.

80 Kingsbridge Rd
Piscataway, NJ 08854, USA
Tel: +1-732-469-0880
Fax: +1-732-469-2298

Contact us: <https://www.audiocodes.com/corporate/offices-worldwide>

Website: <https://www.audiocodes.com/>

©2024 AudioCodes Ltd. All rights reserved. AudioCodes, AC, HD VoIP, HD VoIP Sounds Better, IPmedia, Mediant, MediaPack, What's Inside Matters, OSN, SmartTAP, User Management Pack, VMAS, VoIPerfect, VoIPerfectHD, Your Gateway To VoIP, 3GX, VocaNom, AudioCodes One Voice, AudioCodes Meeting Insights and AudioCodes Room Experience are trademarks or registered trademarks of AudioCodes Limited. All other products or trademarks are property of their respective owners. Product specifications are subject to change without notice.



FCC WARNING

Prior to operating this device, refer to the device's [Regulatory Information and FCC warnings](#).

Notice Information

Information contained in this document is believed to be accurate and reliable at the time of printing. However, due to ongoing product improvements and revisions, AudioCodes cannot guarantee accuracy of printed material after the Date Published nor can it accept responsibility for errors or omissions. Updates to this document can be downloaded from <https://www.audiocodes.com/library/technical-documents>.

This document is subject to change without notice.

Date Published: Apr-18-2024

Document #: LTRT-18286

