

Compact IP Intercoms with HD Video

The **X-205 Series** of Compact IP Video Intercoms are designed to provide HD video and reliable handsfree voice communication for SIP VoIP phone systems and service providers. The built-in IP video camera has H.264 video compression, low light sensitivity, a wide viewing angle of 126 degrees, and can output dual video streams of up to 1080p resolution.

The **X-205** intercoms can dial programmable numbers and be programmed remotely via a built-in Web UI. On-board 2 Amp relay contacts are provided for activating door strikes or gate controllers. The **X-205** will flash the blue LED during dialing and automatically light the LED when the call is answered. All units are PoE class 2 powered.

For outdoor installations where the unit is exposed to precipitation or condensation, the **X-205** intercoms are available with Enhanced Weather Protection (EWP). EWP products are designed to meet IP66 standards and may feature foam rubber gaskets, sealed connections, gel-filled butt connectors, as well as potted circuit boards. For more information on EWP, see DOD 859.



Features

- SIP compliant (see compatible IP-PBX Phone Systems / Service Providers)
- ONVIF Profile S compliant
- 126° wide viewing angle
- H.264 and MJPEG video encoding
- Up to 1080p SIP video calling
- Separate NVR stream with audio up to 1080p
- Selectable video resolutions: 352 x 288, 704 x 526, 720p and 1080p
- Remotely programmable via Web UI
- Can be used with optional RC-4A Secure Relay Controller
- 2 Amp relay contacts for door/gate or optional **SL-2** strobe light (DOD 242)
- Blue backlit 316 stainless steel push button switch
- PoE powered (class 2, < 6.5 Watts)
- Network downloadable firmware
- NDAA Compliant Security Camera
- Vandal resistant stainless steel prevents corrosion
- Laser etched graphics on model **X-205-SS**
- Cycles through backup phone numbers on busy or no-answer
- Optional Enhanced Weather Protection (EWP), EWP products are designed to meet IP66 Ingress Protection Rating (DOD 859)
- Extended temperature range of -40° F to 140° F
- Available finishes: stainless steel, textured black, or oil-rubbed bronze
- Volume adjustments for microphone and speaker
- Surface mounts to a standard single gang electrical box (not included), or mount directly to a wall or flat sided post
- Diagnostics for testing microphone, speaker, and relay



X-205-SS or X-205-SS-EWP
Brushed Stainless Steel

X-205-BK or X-205-BK-EWP
Textured Black Powder Painted Stainless Steel

X-205-BN or X-205-BN-EWP
Oil-Rubbed Bronze Powder Painted Stainless Steel

Installation requires a Network Administrator / IT Technician

Applications

- Front door
- Gate entrance
- Parking ramps/lots
- ATM machines
- Medical centers
- Lobbies
- Entryways
- Stadiums
- Convention centers
- Public access areas

www.VikingElectronics.com
Information: 715-386-8861

Specifications

Power: PoE class 2 (< 6.5 Watts)
Maximum Sound Pressure: 90 dB SPL @ 1m
Dimensions: 5.75" x 3.0" x 1.05" (146 mm x 76 mm x 27 mm)
Operating Temperature: -40° F to 140° F (-40° C to 60° C)
Humidity - Standard Products: 5% to 95% non-condensing
Humidity - EWP Products: Up to 100%
Video Codecs: H.264 and MJPEG
Audio Codecs: G711u, G711a, G722
Network Compliance: IEEE 802.3 af PoE, SIP 2.0 RFC3261, 1000BASE-T with auto cross over
Connections: (1) RJ45 100/1000 Base-T, (5) gel-filled butt connectors
(See page 5 for additional Specifications)

2 - Definitions

Bitrate : The amount of video bits transferred per second. Higher values make for better video definition, but more bandwidth is consumed. Some systems may limit the maximum video bitrate.

Client: A computer or device that makes use of a server. As an example, the client might request a particular file from the server.

Codec (audio encoder/decoder): SIP audio Codecs convert the analog audio to/from digital audio that is sent in the SIP call. The Codec format that is used should be supported by the SIP server and all SIP devices involved in the VoIP call.

DHCP: Dynamic Host Configuration Protocol. In this procedure the network server or router takes note of a client's MAC address and assigns an IP address to allow the client to communicate with other devices on the network.

DNS Server: A DNS (Domain Name System) server translates domain names (ie: www.vikingelectronics.com) into an IP address.

Ethernet: Ethernet is the most commonly used LAN technology. An Ethernet Local Area Network typically uses twisted pair wires to achieve transmission speeds up to 1Gbps.

FPS : Frames Per Second. The number of video frames transmitted per second.

H.264: Video compression for high-definition digital video. Also known as MPEG -4 Part 10 or Advanced Video Coding (MPEG-4 AVC), H.264 is defined as a block-oriented, compensation based video compression standard that defines multiple profiles (tools) and levels (max bitrates and resolutions).

Host: A computer or device connected to a network.

Host Name: A host name is a label assigned to a device connected to a computer network that is used to identify the device in various forms of network communication.

Hosts File: A file stored in a computer that lists host names and their corresponding IP addresses with the purpose of mapping addresses to hosts or vice versa.

Internet: A worldwide system of computer networks running on IP protocol which can be accessed by individual computers or networks.

IP: Internet Protocol is the set of communications conventions that govern the way computers communicate on networks and on the [Internet](#).

IP Address: This is the address that uniquely identifies a host on a network.

LAN: Local Area Network. A LAN is a network connecting computers and other devices within an office or building.

Lease: The amount of time a DHCP server reserves an address it has assigned. If the address isn't used by the host for a period of time, the lease can expire and the address can be assigned to another host.

MAC Address: MAC stands for Media Access Control. A MAC address, also called a hardware address or physical address, is a unique address assigned to a device at the factory. It resides in the device's memory and is used by routers to send network traffic to the correct IP address. You can find the MAC address of your E-10/20/30/32-IP phone printed on a white label on the top surface of the PoE LAN port.

MJPEG (Motion JPEG): A video encoding format in which each video frame or interlaced field of a digital video sequence is compressed separately as a JPEG image.

Multicast : This can refer to RTP Multicasting (audio only), or to RTSP (audio and video). One device is broadcasting a stream to multiple listening devices. A specific IP address and port are used.

Router: A device that forwards data from one network to another. In order to send information to the right location, routers look at [IP Address](#), [MAC Address](#) and [Subnet Mask](#).

RTP: Real-Time Transport Protocol is an Internet protocol standard that specifies a way for programs to manage the real-time transmission of multimedia data over either unicast or multicast network services.

RTSP (Real-Time-Streaming-Protocol): Application level network communication system that transfers real-time data from multimedia to an endpoint device by communicating directly with the server streaming the data.

Server: A computer or device that fulfills requests from a client. This could involve the server sending a particular file requested by the client.

Session Initiation Protocol (SIP): Is a signaling communications protocol, widely used for controlling multimedia communication sessions such as voice and video calls over Internet Protocol (IP) networks. The protocol defines the messages that are sent between endpoints, which govern establishment, termination and other essential elements of a call.

Static IP Address: A static IP Address has been assigned manually and is permanent until it is manually removed. It is not subject to the [Lease](#) limitations of a [Dynamic IP Address](#) assigned by the [DHCP Server](#). The default static IP Address is: **192.168.154.1**

Subnet: A portion of a network that shares a common address component. On TCP/IP networks, subnets are defined as all devices whose IP addresses have the same prefix. For example, all devices with [IP addresses](#) that start with 100.100.100. would be part of the same subnet. Dividing a network into subnets is useful for both security and performance reasons. IP networks are divided using a subnet mask.

TCP/IP: Transmission Control Protocol/Internet Protocol is the suite of communications protocols used to connect hosts on the Internet. TCP/IP uses several protocols, the two main ones being TCP and IP. TCP/IP is built into the UNIX operating system and is used by the Internet, making it the de facto standard for transmitting data over networks.

TISP: Telephone Internet Service Provider

Video Payload: An integer between 96 and 127. This is used for the SDP (Session Description Protocol) to indicate the RTP Payload Type. H.264 and MJPEG video calls fall under the "Dynamic" payload type.

WAN: Wide Area Network. A WAN is a network comprising a large geographical area like a state or country. The largest WAN is the [Internet](#).

Wireless Access Point (AP): A device that allows wireless devices to connect to a wired network using Wi-Fi, or related standards. The AP usually connects to a router (via a wired network) as a standalone device, but it can also be an integral component of the router itself.

Wireless Repeater (Wireless Range Extender): takes an existing signal from a wireless router or access point and rebroadcasts it to create a second network. When two or more hosts have to be connected with one another over the IEEE 802.11 protocol and the distance is too long for a direct connection to be established, a wireless repeater is used to bridge the gap.

3 - Features Overview

FRONT VIEW of the X-205

Network Camera: 1080p video output up to 15 FPS, 126° wide viewing angle. Wide operating temperature of -40°F to 140°F.

Protective Camera Window: Impact resistant polycarbonate lens with scratch resistant coating and water-tight gasket.

Chassis: SS model is 16 gauge 316 stainless steel with a #4 brushed finish. BK and BN models are 16 gauge 304 stainless steel with a durable powder painted finish.

Blue LED: Lights steady to help locate the button in low light, flashes during dialing, then lights steady when answered.

Push Button Switch: Push to initiate call, push again to disconnect. Solid 316 stainless steel internally sealed per IP67.

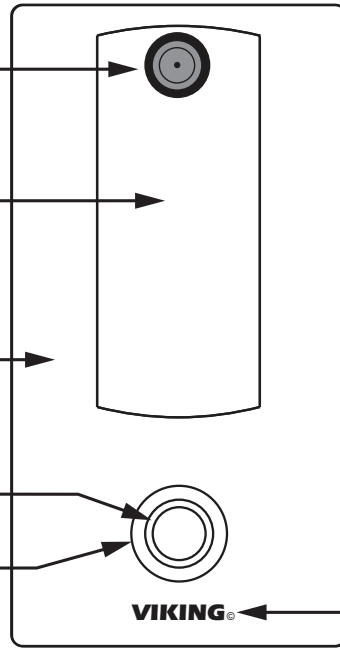

BOTTOM VIEW

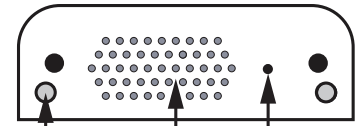

Set Screws:
(2) 8-32 socket x 1/2" long (included)

Microphone:
Omni-directional microphone with protective water-resistant cloth.

Speaker: Mylar speaker with rubber gasket to maintain water-tight seal and eliminate water deterioration.

Laser Etched Graphics: For long lasting easy to read graphics.

REAR (PCB) VIEW of X-205

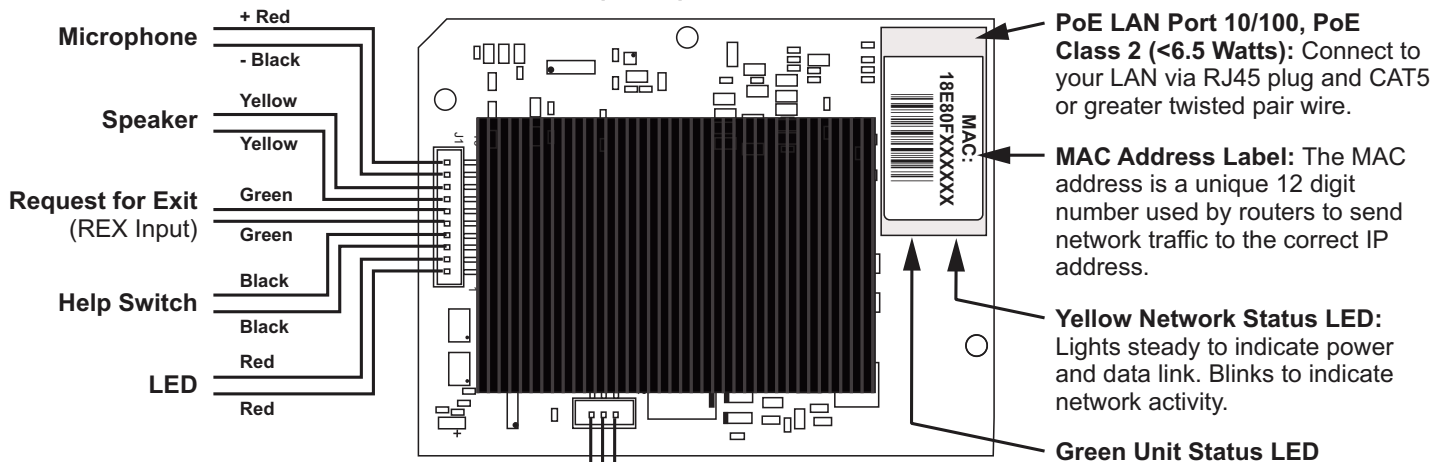

** Note: The gel-filled (water-tight) butt connectors are designed for insulation displacement on 19-26 gauge wire with a maximum insulation of 0.082 inches. Cut off stripped wire ends before terminating.*

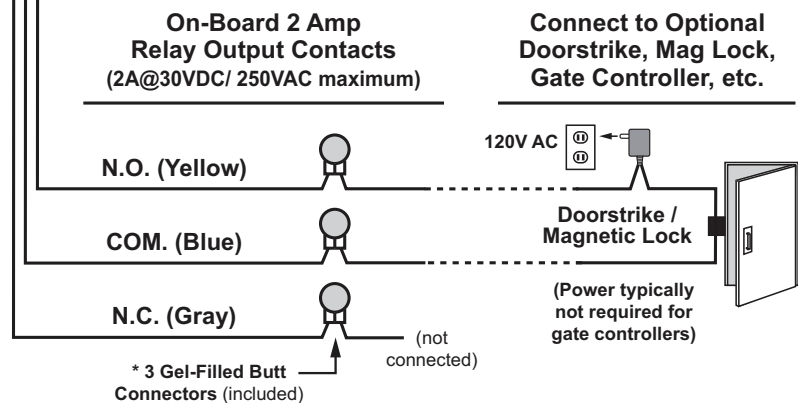

4 - Specifications

Intercom Specifications

Dimensions: 5.75" x 3.08" x 1.05" (146 mm x 78 mm x 27 mm)

Shipping Weight: XX lbs (XX kg)

X-205-SS Faceplate: 0.060" thick (16 gauge) marine grade 316 stainless steel with a #4 brushed finish

X-205-BN Faceplate: 0.060" thick (16 gauge) 304 stainless steel with Oil Rubbed Bronze powder paint finish

X-205-BK Faceplate: 0.060" thick (16 gauge) 304 stainless steel with Textured Black powder paint finish

Blue LED: Call connected LED lights steady to help locate the button in low light, flashes during dialing, then lights steady when answered.

Camera Specifications

Image Sensor: OmniVision OV5645

Resolution: 1080p @ 15 FPS

Sensitivity: 680-mV / lux-second

Lens: 0.25 inch (6.35 mm) fixed focus

FOV (Field of View): 126°

Mounting: Surface mount to walls, posts or single gang electrical boxes. Attach the mounting plate in desired location and connect the wires. Then, secure the phone to the mounting plate with provided 8-32 set screws.

Optional Enhanced Weather Protection (EWP) Available: EWP products are designed to meet IP66 standards and may feature foam rubber gaskets, sealed connections, gel-filled butt connectors, as well as potted circuit boards with internally sealed, field-adjustable trim pots and DIP switches for easy onsite programming. For more info on EWP, see **DOD 859**.

Note: For greater weather resistance, apply a bead of clear silicon caulking around the top edge and sides of the chassis.

5 - Mounting

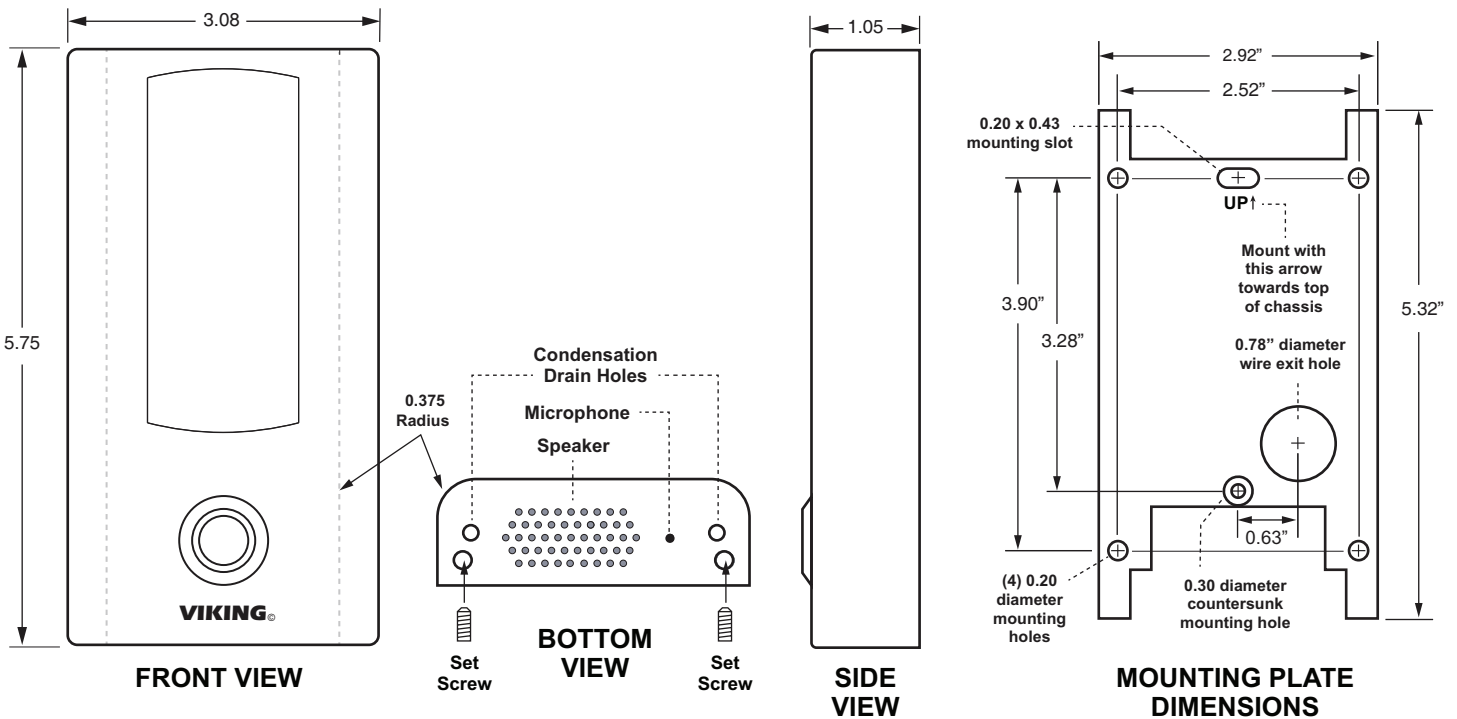

6 - Typical Installation on SIP Based VoIP Phone System

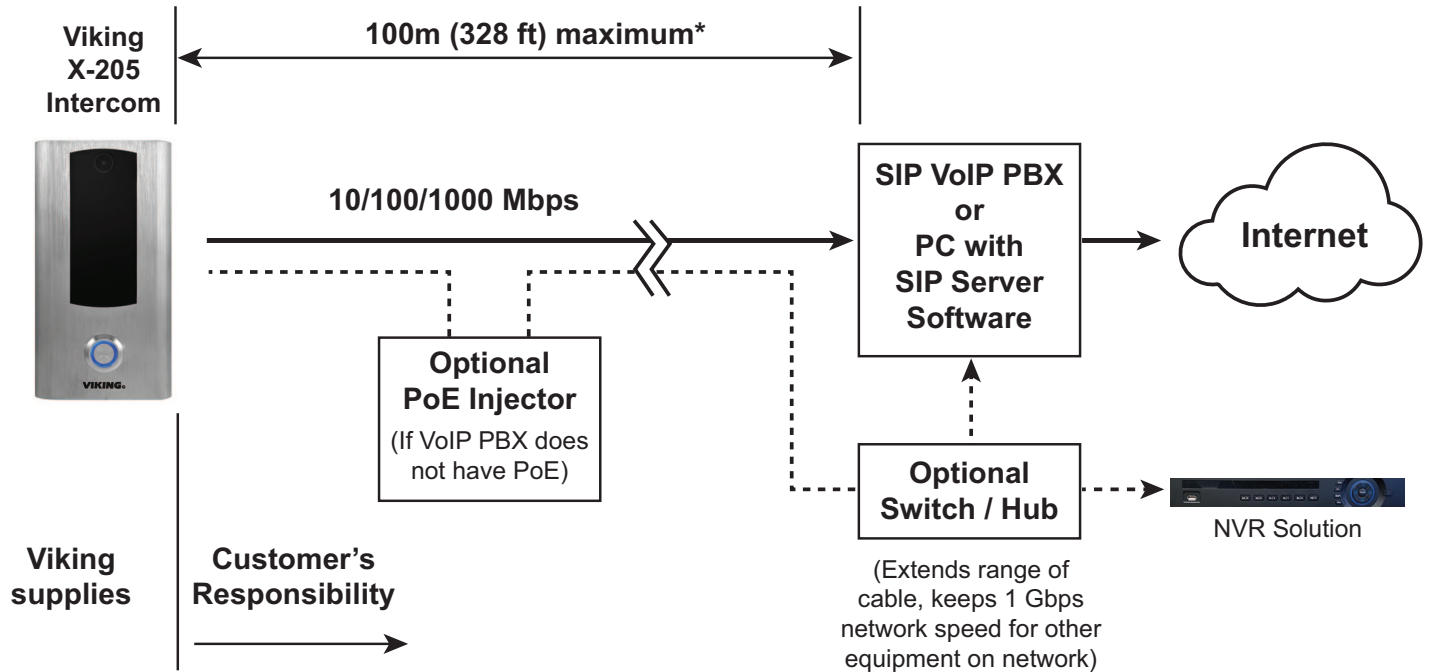

*** Note:** A PoE extender can be used for an additional 100 meters per extender. For longer runs (up to 2 km / 1.2 miles) an ethernet to fiber media converter can be used.

7 - Network Infrastructure Requirements

- 10/100 or 1 Gbps network connection with PoE (Class 2)
- Ethernet Cable: Cat 5e or greater
- Browser for accessing the X-205 Web UI for Programming. Supported browsers: Chrome, Firefox, Opera, and Konquerer
- Computer with X-Series Discovery Utility (to find the unit's IP address for UI access).
- X-Series Discovery Utility Software
Download here: https://vikingupgradeserver.com/_install/X-Discovery.zip

8 - Initial Set-up

Install and run the **X-Series Discovery Utility** software. **X-205** units on the same LAN will show up with their IP addresses. Double-click on a unit to open the Web UI in your default browser. Once your IP address is known, you can open the Web UI in a smartphone browser.

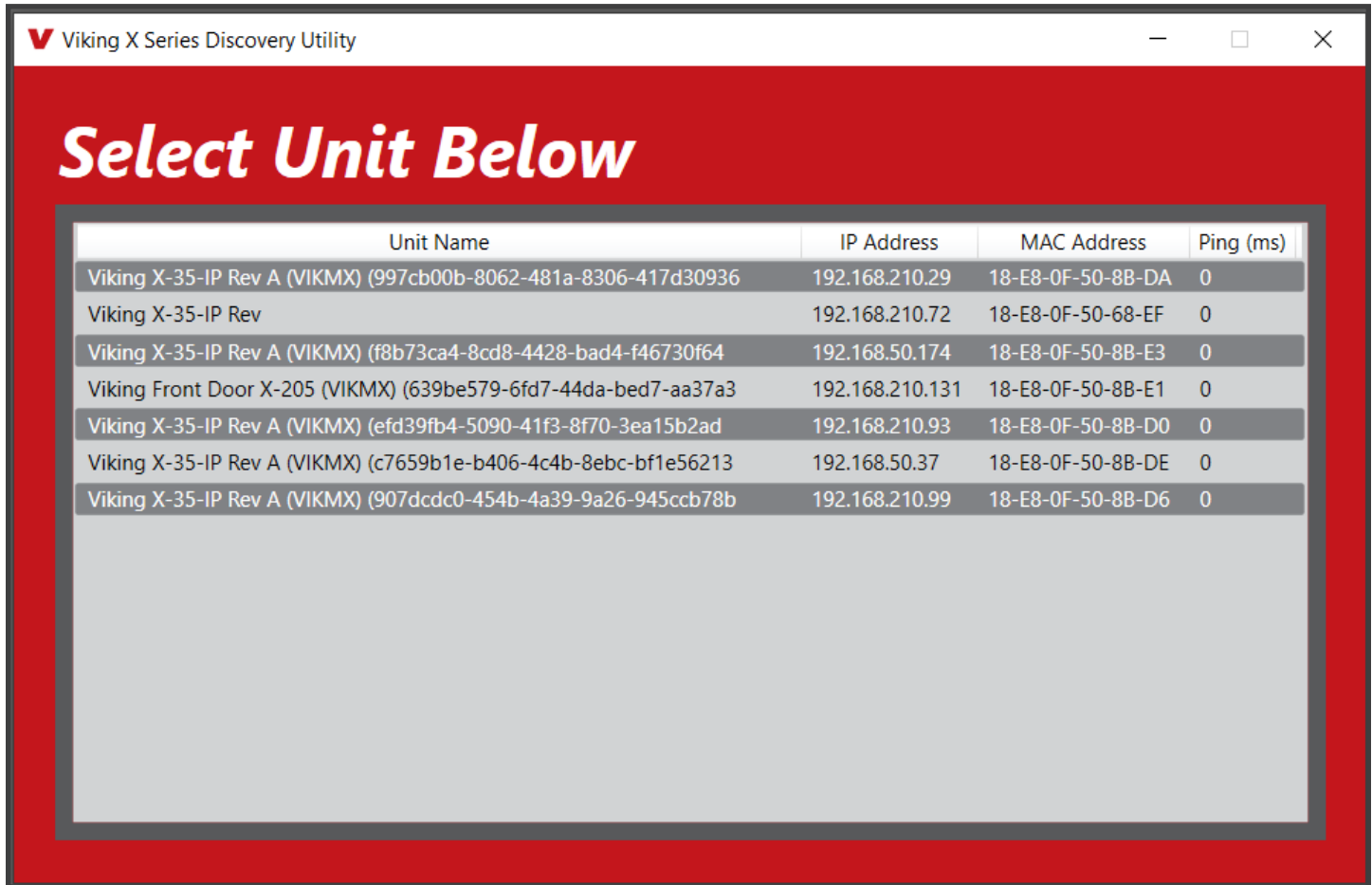

STEP 1	Install the unit using Cat 5e (or greater) Ethernet cable. The X-205 is PoE powered (class 2). We suggest a managed PoE switch, but it is not required. A PoE injector is acceptable.
STEP 2	After the unit is powered, it will boot up (30 to 45 seconds). The unit will then listen to discovery messages from the X-Series Discovery Utility or from an Onvif compliant NVR.
STEP 3	Download and run the X-Series Discovery Utility . Any X-205 devices on your LAN should be displayed. Simply double-click on the unit's name/address in the Discovery window to open the Web UI. Alternatively, if the IP address of the X-205 is known, type it in the address bar of your browser to access it (defaults to https://X35's IPADDRESS).
STEP 4	If you do not want to install/run the X-Series Discovery Utility , the Web UI can also be accessed via IP address or "Hostname".local on your LAN. The default Hostname is the unit's MAC address without the ":" separators (e.g. HTTPS://18e80f508bda.local).
STEP 5	If a unit cannot be accessed (example: set to a Static IP that is not available), a hard reset can be performed to reset all settings to defaults (unit will start out as DHCP).
STEP 6	To reset the unit, hold down the call button on the front panel while cycling power. The unit will beep 2 times, then flash the LED for about 10 seconds and then beep four times. Release the button within 3 seconds of the 4 beeps. The unit will reboot itself and come back up with factory defaults settings. Note that this reboot takes 30-60 seconds.

9 - Web UI

To open the UI, enter the **X-205**'s IP address in the address bar of your browser. HTTPS is default. If your browser shows an insecure connection, click on the "Lock" icon near the address bar. View the CA certificate and add it to the Certificate Store on the computer that will be used for access.

If the **Viking X-Series Discovery Utility** is used, double-clicking on the unit will attempt to login with the default password.

Click on **Login**.

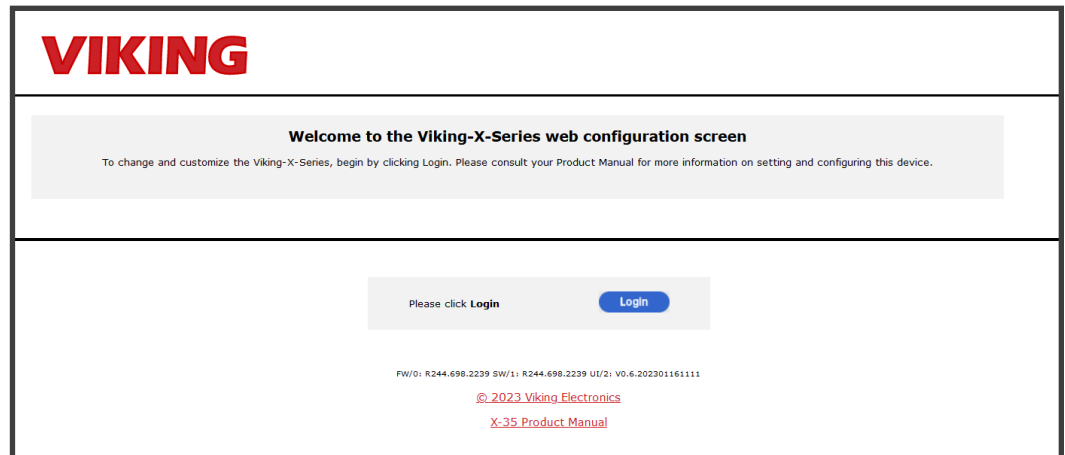

For the first login, sign in as:

Username: admin

Password: admin

You will be prompted to change to a non-default password for security.

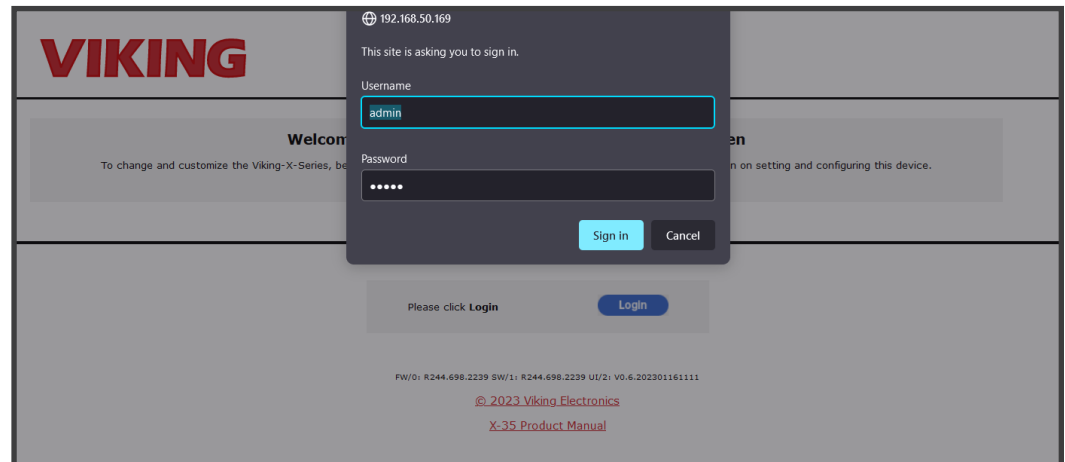

Home Tab

The Home tab opens and displays Basic Configuration Information about the unit, including registration status.

A green dot indicates the unit is registered and the network is OK. A yellow dot would indicate an error with SIP registration or the network.

The screenshot shows the VIKING web interface. At the top, there is a navigation bar with tabs: Home, Basic, VoIP, Admin, Status, Configure, and Stream. The 'Home' tab is selected. On the left, there is a sidebar menu with options: Telephony Setup, Network Setup Wizard, and Logout. The main content area is titled 'General Status' and 'Basic Configuration Information'. It displays the following information: Phone Number: (blank), VoIP Status: Registered (with a green dot), Hostname: 18e80f508bde.local, LAN IP Address: 192.168.50.169, LAN Connected via: DHCP [86400 second lease], System Date: Wed Jan 25 09:19:31 2023, System Uptime: 1195 minutes, and VCA Firmware Revision: V0.6.202301161403. There is a 'Stop Refresh' button at the bottom right. At the bottom of the page, there is the ONVIF logo and copyright information: © 2023 Viking Electronics and a link to the X-35 Product Manual.

Basic Tab

The Basic tab contains many of the initial IP/Network settings such as DHCP or static IP.

The unit will default to DHCP, making it easier to initially configure. Once an IP address is reserved, it can be used as the unit's static IP, which is easier to find the IP address of the unit for Web UI configuration.

The screenshot shows the VIKING web interface with the 'Basic' tab selected. The navigation bar and sidebar are the same as in the Home tab. The main content area is titled 'ISP Connection' and 'ISP Connection Settings'. It includes a note: 'Click a button to indicate your Internet connection type. Contact your ISP if you are not sure.' There are two radio buttons: 'Dynamic IP Address' (selected) and 'Static IP Address'. The 'Dynamic IP Address' option has a sub-section 'Most Cable Users' with a text box containing 'Your ISP assigns your IP address automatically.' The 'Static IP Address' option has a text box containing 'Your ISP assigns a permanent IP address which you must enter.' Below this is the 'DHCP Client Settings' section, which includes 'Support failover to IPv4LL:' set to 'Disable' and 'Support ARP Probe:' set to 'Enable'. The 'DNS service' section is titled 'Configure your DNS Servers.' and includes fields for 'Primary DNS Server:' (8.8.8.8), 'Primary DNS Server:' (192.168.50.1), 'Alternate DNS 1:', 'Alternate DNS 2:', 'Hostname:' (18e80f50ffff), 'Domain Suffix:' (local), and 'Search Domains:'. At the bottom, there are 'Cancel' and 'Apply' buttons. The footer contains the ONVIF logo and copyright information: © 2023 Viking Electronics and a link to the X-35 Product Manual.

VoIP Tab

The VoIP tab is used for SIP settings. Enter your SIP credentials here. The **X-205** will attempt to register after the “Apply” button is clicked.

The screenshot shows the VIKING web interface for VoIP settings. The top navigation bar includes Home, Basic, VoIP, Admin, Status, Configure, and Stream. The left sidebar has Account, Audio, Security, and Logout. The main content area is titled 'VoIP' and 'Account Settings'. It contains several input fields for SIP configuration: Phone Number/UserID (User/Extension), Authentication ID (Auth. ID), Authenticated Password (SIP Password), Caller ID (optional), Registrar:port (sip.myviking.com : 5060), Primary proxy:port (primary.proxyserver.net : 5060), Secondary proxy:port (secondary.proxyserver.net : 5060), Local port (5060), SIP Registration Expiry (1800), SIP Registration Routing (SIP Registrar), ICE (Disable), STUN (Disable), and TURN (Disable). Below these are fields for STUN server:port (STUN server address : 3478), TURN server:port (TURN server address : 3478), and TURN user:pass (Turn user name : pass). At the bottom, there are 'Apply Changes' instructions, 'Cancel' and 'Apply' buttons, the ONVIF logo, and copyright information: © 2023 Viking Electronics, X-35 Product Manual.

Admin Tab

The Admin tab is used for advanced settings such as changing the unit's password, or updating firmware.

Use the Backup and Restore feature to save all settings for future use, or for provisioning multiple units.

When a configuration is downloaded, it creates a file named “x-series-backup.xml” in your downloads directory.

The screenshot shows the VIKING web interface for Admin settings. The top navigation bar includes Home, Basic, VoIP, Admin, Status, Configure, and Stream. The left sidebar has Passwords, Firmware, Reset, Backup and Restore, Ping Test, Audio Files Management, and Logout. The main content area is titled 'Admin' and 'Passwords'. It contains a section for 'Administrative Setup' with the instruction 'Configure the administration settings for the VoIP device'. Below this are input fields for Login Username (admin), New Password, and Confirm New Password. At the bottom, there are 'Apply Changes' instructions, 'Cancel' and 'Apply' buttons, the ONVIF logo, and copyright information: © 2023 Viking Electronics, X-35 Product Manual.

Admin Tab

Audio Files Management

The Audio Files Management page is used to upload WAV files. Click on the Browse button and select your WAV file. Then click on Upload to send the file. The format should be 8 kHz, 8 or 16-bit PCM, mono WAV file. A stereo file can be uploaded, and it will be automatically converted to mono before it is uploaded.

When enabled, the Announcement is played on outbound SIP calls once the call is connected. This audio is heard from the speaker and sent to the connected device, see page 16.

VIKING

Home Basic VoIP **Admin** Status Configure Stream

Audio Files Management

Audio Files Management

Manage audio files on VoIP device

Filename	Filesize	Remove	Play
8K RideOf Valkeries 16 bit 7 sec.vsf	32		
BUSY.vsf	47		
chime.vsf	5		
COMP.vsf	37		
CON.vsf	46		
LOST.vsf	46		
NCON.vsf	44		

No file selected.

Valid file format is 8 kHz, 8 or 16-bit PCM, mono WAV file.

© 2023 Viking Electronics
[X-35 Product Manual](#)

ONVIF®

Status Tab

The Status tab includes system and Network Packet information.

Use this page to set your “Device Name”. This is the name that will be broadcast to the network for discovery.

There are separate monitors for different IP protocols such as monitoring TCP connections to the unit.

VIKING

Home Basic VoIP Admin **Status** Configure Stream

Status

System Information

Admin Contact:

Device Location:

Device GPS coordinates:

Device Name:

Hardware Revision: Viking-X-35-Rev.A

Software Revisions: [R244.709.2312](#)

Hostname: 18e80f50ffff.local

Model: X-35-IP

LAN Ethernet MAC: 18:e8:0f:50:ff:ff

System Date: Wed Mar 29 08:28:52 2023

System Uptime: 157794 Seconds

Apply Changes

© 2023 Viking Electronics
[X-35 Product Manual](#)

ONVIF®

Stream Tab

Onvif NVR User Settings

Additional Onvif users can be added on the stream tab. Users have a selectable level of access. Choices are Admin, Operator, User, or Anonymous. For example, someone that should only have rights to view the stream without modifying any settings should be assigned the 'User' level.

To add a new user, follow these steps:

STEP 1	Enter the username
STEP 2	Enter the password (8 characters with at least one capitol letter)
STEP 3	Select the user level.
STEP 4	Click the 'Add' button to update the list.
STEP 5	Repeat steps 1-4 to add more users.
STEP 6	When all users are added, click on 'Apply' to send the list.

Important: The users 'admin' and 'operator' cannot be removed. Editing user names and/or passwords is not allowed after the list has been 'Applied'. To modify a user, delete the user and create a new one.

Stream Tab

Call Stream Settings

These values are requested on an outbound call from the **X-205**. The Call (SDP) negotiation may reduce these values to lower values based on the SIP server/SIP endpoint limitations.

Inbound calls to the **X-205** device may have different values requested, the SDP will negotiate down if necessary.

Setting	Description	Factory Default
Bitrate	The maximum allowed bitrate (Kb/s) for video during a SIP call. Acceptable range is 100-10000.	2500 Kb/s
FPS	The maximum allowed frames per second for video during a SIP call. Acceptable values are 1-15 FPS.	15 FPS
Resolution	The maximum allowed width and height of the video during a SIP call. There are four selectable resolutions: 1920x1080, 1280x720, 704x576, and 352x288.	1920x1080

Stream Tab

RTSP Stream Settings

These settings will affect the video stream sent to the NVR. These settings can also be configured through your NVR which will use Onvif compliant requests to change video and audio streaming settings. If a video stream is already running, it will have to be restarted for the setting to take effect.

The screenshot shows the VIKING NVR web interface. At the top, there is a navigation menu with tabs: Home, Basic, VoIP, Admin, Status, Configure, and Stream. Below the menu, there is a sidebar with a tree view containing: NVR Users, Call Stream, RTSP Stream (selected), and Logout. The main content area is titled 'Configure RTSP Stream Settings' and contains the following settings:

- RTSP: Enabled (dropdown)
- RTSP Encoder: H264 (dropdown)
- RTSP Resolution: 1920x1080 (dropdown)
- RTSP Multicast: Disabled (dropdown)
- RTSP Port(1-65535): 554 (text input)
- RTSP Multicast Address: 234.86.73.75 (text input)
- RTSP Video Port(1-65535): 5004 (text input)
- RTSP Bitrate: 2048 (text input)
- RTSP FPS(1-30): 30 (text input)

At the bottom of the settings area, there are three buttons: 'Apply Changes' (text), 'Cancel' (red outline), and 'Apply' (blue). Below the buttons, there is a copyright notice: '© 2023 Viking Electronics X-35 Product Manual' and the ONVIF logo.

Setting	Description	Factory Default
RTSP	Enabled or Disabled. When set to disabled the RTSP server is disabled. The RTSP stream cannot be viewed by an NVR.	Enabled
RTSP Encoder	H264 or MJPEG. Selects the encoding for the video sent from the RTSP server.	H264
RTSP Resolution	The width and height of the video sent from the RTSP server.	1920x1080
RTSP Multicast	Enabled or Disabled. When enabled, video from the RTSP server is sent to the programmable multicast address. The stream can be viewed with a media player, or an older NVR that is not Onvif compliant.	Disabled
RTSP Port	1-65535. This is the port the RTSP stream is negotiated on.	554
RTSP Multicast Address	234.0.0.0-238.255.255.255. This is the address the RTSP multicast is sent to when RTSP multicast is enabled.	234.86.73.75
RTSP Video Port	1025-65535. The port the RTSP video will be sent to.	5004
RTSP Bitrate	The H264 bitrate limit in Kb/s. The acceptable range is 64-8000 (Kb/s).	2048 Kb/s
RTSP FPS	1-30 FPS. The maximum allowed frames per second of the RTSP video stream. This will reduce automatically when a SIP call is also sending video.	30 FPS

Configure Tab

Phone Settings

Speed dial numbers, call/dialing options and volume levels are set on the Phone Settings Tab. These settings are used to control how the device acts during inbound and outbound SIP calls.

Setting	Description	Factory Default
Speed Dial Numbers	These are the phone numbers/extensions the X-205 will dial after pressing the Call button. The numbers are dialed top to bottom in order, once a call is answered the dialing sequence is ended.	n/a
Access Code	1-6 digits. This code must be entered by a caller before the relay can be controlled. This only applies to calls inbound to the X-205 . A long access code makes the unit more secure, but keep in mind it will likely be manually dialed by a caller from their SIP device. Note: In-band DTMF detection is not supported at this time.	123456
Auto Answer	When disabled, the unit will ring (if enabled) or reject the call if both auto answer and loud ring are disabled.	Enabled
Call Time	Affects outbound calls made by the X-205 . Set to 0 to disable the timer. Resolution is in seconds, 1-999.	180 (3 minutes)
Loud Ring	When enabled, the unit will emit a loud ring signal from its speaker when its SIP extension is ringing. The call button can be pressed to answer the call. The inbound call time limits the "ring" time.	Disabled
Ring Volume	Changes the volume of Loud Ringing.	6
Inbound Call Time	Affects inbound ringing calls made to the X-205 . Set to 0 to disable the timer. Resolution is in seconds, 1-999.	180 (3 minutes)
Speaker Volume	0-99. Changes the level of the audio produced by the X-205 speaker.	6
Mic Volume	0-99. Changes the level of the audio from the X-205 microphone.	6
Use Call Progress	Enabled/Disabled. Set this to enable when the X-205 is calling outside of the building and analog audio detection is required.	Disabled
Lap Counter	The number of times the group of programmed numbers is dialed. 0 = continuous dialing. Example: 5 numbers are programmed, Lap Counter is set to 3. The unit will dial 15 times (3 laps of 5 numbers).	7

Setting	Description	Factory Default
Redial on Busy	Enabled/Disabled. When enabled the unit will dial again after a call fails or busy signal is heard. When disabled the unit hangs up after a failed/rejected call.	Enabled
LED Mode	This setting determines how the LED on the X-205 will act when idle and during calls.	
	LED Mode	Description
	Entry Phone	The LED will remain ON in the idle state, turn off while button is pressed, blink during dialing, light steady when the call is answered, then turn OFF momentarily when the call is completed.
	Emergency Phone	The LED will remain OFF in the idle state, blink during dialing, light steady when the call is connected, then turn OFF when the call is completed.
	Emergency Phone Outbound Only	On outbound calls, the LED will remain OFF in the idle state, blink during dialing, light steady when the call is connected, then turn OFF when the call is completed. On inbound calls, the LED will remain off. This is useful for silent monitoring on inbound calls.
Off	Stays off when idle and during connected calls. Flashes on boot up, during dialing, and when the unit has a Network/Registration error.	Entry Phone
Ring Timeout	This value is how many seconds the X-205 will try to call the “Numbers”. Once a call is answered this timer stops and the Call timer is in control. This only affects outbound calls from the X-205 .	30
Alarm Mute	When the SIP/Network Alarm is active (unit is not registered, or a network error) the X-205 will beep 3 times every 30 seconds. The LED on the button will also flash. When Alarm Mute is set to enabled, the LED will still flash but no beeps are produced for the Alarm.	Disabled

Configure Tab

Advanced Phone Settings

The advanced phone settings page contains additional phone features from legacy Viking products. These settings are used before and during SIP video calls.

Setting	Description	Factory Default
Speaker Mode	This setting determines how the speaker on the X-205 will function.	
	Speaker Mode	Description
	On	The speaker is active during inbound and outbound calls.
	Silent Monitor	The speaker is will be muted during inbound and outbound calls.
	Off Until Answered	The speaker will remain off until an outbound SIP call is connected. On inbound calls the speaker will function normally.
On		
Id Number	The Id Number is an In-band or RFC 2833 DTMF string sent to the calling party after a “*” is dialed. Leave blank to disable this feature.	Blank - disabled
Daily Test Call	When set to Enabled, the device will make a SIP call once a day at a programmable hour.	Disabled
Test Call Start Time	The time of day the unit will make the Daily Test Call.	02:00 AM
Alternating Switch Action	When enabled, a VoIP call can be ended with the button. When disabled, calls can only be started with the button.	Enabled
Call Led Control	During outbound calls, the LED can turn on when the call is connected, or wait until a “*” is received.	Automatic
Vox Sensitivity	1-10. Higher values make the unit more sensitive to audio from the called party.	5
Vox Delay	1-10 (100 mS to 1 S). The amount of switching time to switch between talk and listen modes.	5 (0.5 seconds)

Configure Tab

Announcement Settings

When enabled, the Announcement is played on outbound SIP calls once the call is connected. This audio is heard from the speaker and sent to the connected device. The Announcement will also play on inbound calls if the Access Code and a “*” are dialed. The Number Of Announcements setting controls how many times the audio file will automatically play (8 seconds between plays). Select your uploaded file from the Announcement Filename drop down (your file will have a “.vsf” file extension). If you have not uploaded a file yet, click on the Manage button to open Audio Files Management, see page X.

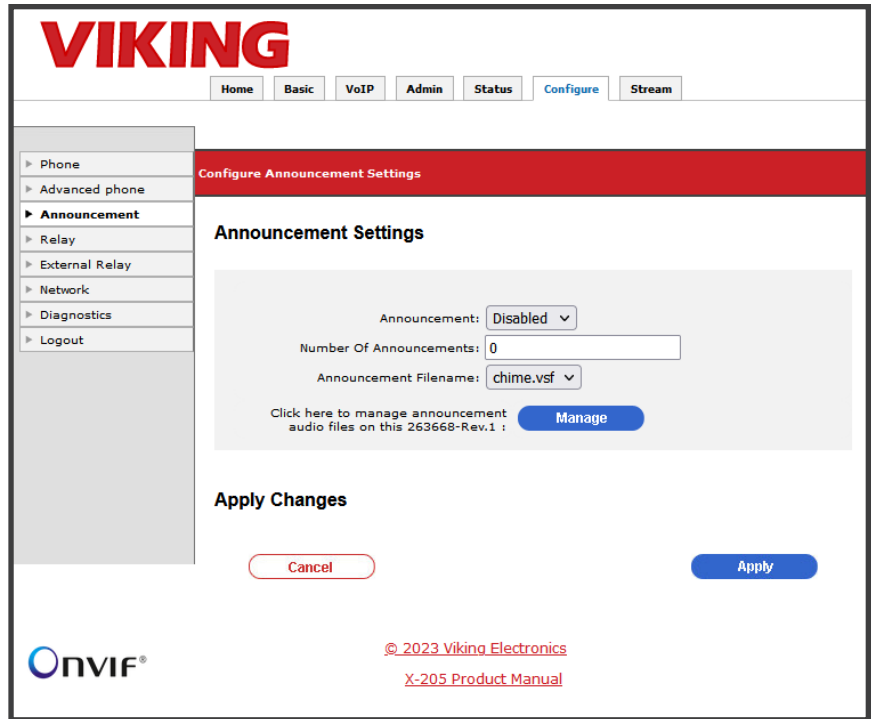

Configure Tab

Diagnostics

Mic/Speaker Diagnostics:

The microphone and speaker are tested at the same time when the Run Test button is clicked. A tone will play from the speaker, and the microphone will listen. Background noise can affect this, so there are configurable values for audio levels (Mic Level, Speaker Level). In quiet areas, these can be lowered, in louder areas they may have to be increased.

Relay Diagnostics:

The Relay Diagnostic allows you to test your relay contact wiring without making a SIP call. Enter the Activation Time you would like the relay to stay on for and click on Run Relay Diagnostic. The button in the UI will turn Green for the duration of the closure.

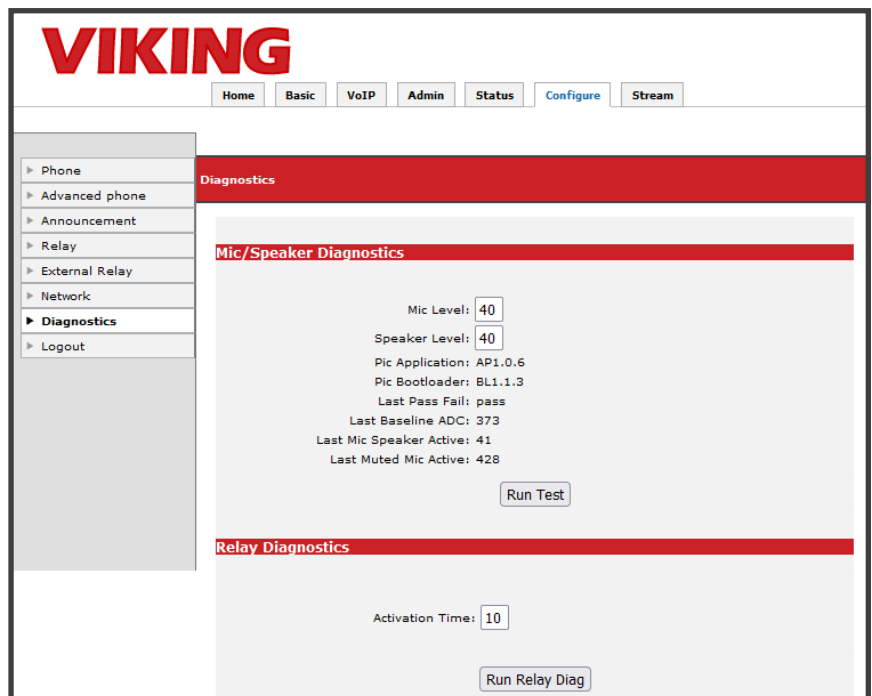

Configure Tab

Relay Settings

The relay settings are set here. Select the relay mode (or disable it) and set your DTMF codes for controlling the relay.

Note: Relay must be set to “Door Strike Mode” to use DTMF to control the relay.

Setting	Description	Factory Default
Relay Mode	Select the mode you would like the relay to operate.	
	Relay Mode	Description
	Disabled	The relay is disabled at all times.
	Door Strike Mode	The relay can be controlled with Touch tones received by the X-205 . The Door Strike Code, Off Code and On Code can be entered during a call. The REX Input can also be used to control the relay.
	Outbound Call	The relay will activate while outbound calls from the X-205 are connected.
	Inbound/Outbound Call	The relay will activate when calls to/from the X-205 are connected.
	Doorbell	The relay will activate for the programmable Door Strike Time at the beginning of an outbound call.
	Alarm	The relay will activate continuously while the X-205 is registered to a SIP server. When the SIP/Network Alarm activates the Relay will de-energize.
	Ring	The relay will activate continuously while the X-205 's extension is ringing, and the “Loud Ring” feature on the X-205 is enabled.
	Ring Flash	The relay will activate in a 500mS on/off pattern while the X-205 's extension is ringing, and the “Loud Ring” feature on the X-205 is enabled.
Door Strike Buzz	Enabled or Disabled. When enabled, a buzz will be heard after a valid Door Strike Code is dialed. This buzz should match the Door Strike time up to 5 seconds. The volume of this Door Strike Buzz matches the Speaker volume setting.	Enabled
Door Strike Code	When this code is dialed, the relay will turn on for the length of the Door Strike Time.	**
Door Strike Time	The length of time (in seconds) that the relay will activate for (after Door Strike Code or REX input). 0.5-99 seconds (enter 0 for 0.5 second closure).	5 seconds
Off Code	When this code is dialed the relay will latch off (1 beep is heard from the X-205 speaker).	10
On Code	When this code is dialed the relay will latch on (2 beeps are heard from the X-205 speaker).	11
Relay Buzz Volume	0-10. Level of the buzz heard after a momentary relay activation.	5

NOTE: “Off” and “On” codes are also referred to as latching commands. These can be disabled by deleting them. This will prevent the relay from being stuck in an open position.

Configure Tab

RC-4A Network Relay Control

The External Relay page will show you a list of RC-4A devices on your network. In order to connect an X-Series Device to one of them, click on the '+' button near under the Select column.

The screenshot shows the VIKING web interface. The top navigation bar includes Home, Basic, VoIP, Admin, Status, Configure, and Stream. The left sidebar has a menu with options: Phone, Advanced phone, Announcement, Relay, External Relay (selected), Network, Diagnostics, and Logout. The main content area is titled 'External Relay Settings' and contains a table with columns: Device Name, MAC Address, IP Address, and Select. A single device 'MYVIKING' is listed with MAC address 18-E8-0F-50-1B-84 and IP address 192.168.210.229. Below the table, the 'Enabled' dropdown is set to 'Disabled'. Other fields include MAC Address, IP Address, Username (admin), Password (viking), and Mirror Index (1). A 'Discover Units' button is present. At the bottom, there are 'Apply Changes', 'Cancel', and 'Apply' buttons.

The RC-4A's IP address and MAC address will be copied into the text boxes. Enter your RC-4A user name and password (the RC-4A defaults are admin:viking). Click 'Apply' to save the changes. Any relay activations will trigger the RC-4A relay matching the 'Mirror Index'.

If no RC-4A units are discovered, check your connections, and make sure the RC-4A is on the same LAN as the X-Series device.

This screenshot is similar to the one above but shows the 'Enabled' dropdown set to 'Enabled'. The MAC Address field is populated with 18-E8-0F-50-1B-84, and the IP Address field is populated with 192.168.50.112. The other fields (Username: admin, Password: viking, Mirror Index: 1) and the 'Discover Units' button remain the same. The 'Apply Changes', 'Cancel', and 'Apply' buttons are also visible at the bottom.

Setting	Description	Factory Default
Enabled	Turns Network Relay Interaction on or off.	Disabled
MAC Address	The MAC address of the RC-4A. Use the '+' button to copy this value into the field.	Blank
IP Address	The IP Address of the RC-4A.	Blank
RC-4A user name	The user name used to authenticate with the RC-4A.	admin
RC-4A password	The password used to authenticate with the RC-4A.	viking
Mirror Index	The relay on the RC-4A you would like to control (1-4).	1

Configure Tab

Network Settings

Advanced network settings are found on this page. Configure your VLAN settings as well as DHCP/Static IP settings. Using this page, when Apply is clicked a pop-up warning will be seen, when confirmed the unit will reboot. If the IP address is changed, use the new address to connect to the unit once it reboots (about 45 seconds).

The screenshot shows the VIKING X-205 web interface. The top navigation bar includes 'Home', 'Basic', 'VoIP', 'Admin', 'Status', 'Configure', and 'Stream'. The left sidebar menu has 'Phone', 'Advanced phone', 'Announcement', 'Relay', 'External Relay', 'Network' (selected), 'Diagnostics', and 'Logout'. The 'Configure Network' header is visible. The 'Network Settings' section includes the following fields:

- Mode: DHCP (dropdown)
- Static IP Address: 192.168.50.242
- Static Netmask: 255.255.255.0
- Static Gateway: 192.168.50.1
- DNS: + (plus icon)
- MAC Address: 18E80F50EEEE
- NTP Server: pool.ntp.org
- Syslog Server: (empty)
- VLAN Interface: Disabled (dropdown)
- ID For All Packets: 0
- PCP For All Packets: 0
- PCP For SIP Packets: 3
- PCP For RTP Packets: 5
- VLAN DHCP Mode: Enabled (dropdown)
- VLAN Static IP Address: 172.16.154.1
- VLAN Static Netmask: 255.255.255.0
- VLAN Static Gateway: 192.168.50.1

At the bottom, there are 'Apply Changes', 'Cancel', and 'Apply' buttons. The footer includes the ONVIF logo and copyright information: © 2023 Viking Electronics, X-205 Product Manual.

Setting	Description
Mode	DHCP or Static. When set to DHCP the X-205 will be automatically assigned an IP address. The last known good IP address will be displayed at the "Static IP Address". If a Static IP is to be used, change the mode to static and make sure the Static IP in the field is available before applying changes, as this may cause the unit to become unreachable. The factory default is DHCP.
Static IP Address	To use Static IP, assign an IP address in your Router/DHCP table before connecting the X-205 to the Network. The unit can also receive a DHCP address, and then can use that same address as a Static once the DHCP mode is changed to Static and a reset/reboot is performed.
Static Netmask	This is the Subnet mask that will be used when the DHCP mode is set to Static. By default, the last known good Subnet Mask is displayed in this field. The factory default is 255.255.255.0
Static Gateway	The IP address of the network gateway. Similar to your P the unit will need a gateway for internet connectivity. This is likely the IP address of your router or DHCP server.
DNS	This is usually assigned automatically by the network, but multiple DNS servers can be programmed into the X-205 . A good alternate DNS is 8.8.8.8 (Google DNS Server).
MAC Address	This is the unique identifier of the X-205 . Every network device has a unique MAC address.
NTP Server	This value is the IP address/URL of the NTP server the X-205 will sync with. You can use ours at "2.viking.pool.ntp.org".
Syslog Server	Enter the IP address you would like to send Syslog messages to. Another Application or device will need to listen for these UDP messages at that address to display them. This feature is enabled/disabled by the Remote Logging setting found on the Basic tab. This log will show calls, connection events, and any network errors. This is crucial for Security as the log can be stored in a secure location. There is also a syslog that can be viewed on the status tab, and is stored locally on the X-205 . Viking offers a Syslog listening app for windows. Find it at https://vikingelectronics.com/wp-content/uploads/Syslog.zip .

Setting	Description	Factory Default
VLAN Interface	Enabled or Disabled (Factory set to Disabled). When set to enabled (and changes are applied) the X-205 will reboot using the VLAN interface. Be sure all other VLAN settings are properly configured before applying changes.	Disabled
ID For All Packets	VLAN Identifier. Set to "0" by default to make sure if you enable VLAN by accident, but do not select the proper tag, The VLAN setting will not take effect ("0" is reserved and cannot be used as a VLAN ID). Change this to the proper tag for your VLAN.	0
PCP For All Packets	Priority code point for all traffic. This includes TCP, TLS, and all other packets to and from the X-205 on the VLAN. This is set to "0" by default (highest priority), this is the best option for NVR streaming. This can be changed if your network infrastructure requires it.	0
PCP For All SIP Packets	Priority code point for all SIP traffic. This is set to "3" by default. It is set lower than the All Packets PCP, but higher than the RTP PCP which should prevent SIP calls from being dropped due to network congestion.	3
PCP For All RTP Packets	Priority code point for all RTP traffic. This is set to "5" by default. This is a lower priority than SIP traffic to prevent SIP calls from being dropped due to network congestion.	5
VLAN DHCP Mode	Enabled or Disabled	Enabled
VLAN Static IP Address	IP address that should be reserved before enabling VLAN.	172.16.154.1
VLAN Static Netmask	Netmask for the VLAN Interface.	255.255.255.0
VLAN Static Gateway	Gateway for the VLAN Interface.	n/a

VLAN Operation

When set to Enabled, the **X-205** will create a new network interface and receive/send packets that have the selected "ID For All Packets". You can also set the PCP separately for SIP or RTP.

The VLAN interface can be set to use a DHCP address (default) or a Static IP. If a static IP is used, be sure your DNS is setup properly. Multiple DNS servers can be added with the green button, if one fails the next one will be tried.

Once VLAN is enabled and the unit is rebooted (happens automatically after changing network settings), the device will come up with it's new IP address. If there is an issue trying to access the Web UI of the **X-205** after enabling VLAN tagging, there is a backup address for access. Use https://<mac_Address>.local replacing <mac_Address> with your device's mac (all lower case, no special characters).

10 - VoIP Settings

SIP Server/SIP Provider

To configure an **X-205** device to register to a SIP Server or SIP Provider, enter the Phone Number (or SIP extension name), SIP Password, Authentication ID (if required), and the IP Address/URL of the SIP Server. Enter the SIP port that will be used, if this is blank port 5060 will be used.

The default SIP protocol is UDP, if TLS or Secure RTP is to be used, change this setting on the VoIP-Security page.

VIKING

Home Basic **VoIP** Admin Status Configure Stream

Account Settings

Phone Number/UserID: 1029
 Authentication ID: 123456
 Authenticated Password: Password1
 Caller ID: GS 1029
 Registrar:port: 192.168.210.208 : 5060
 Primary proxy:port: primary.proxyserver.net : 5060
 Secondary proxy:port: secondary.proxyserver.n : 5060
 Local port: 5060
 SIP Registration Expiry: 1800
 SIP Registration Routing: SIP Registrar
 ICE: Disable
 STUN: Disable
 TURN: Disable
 STUN server:port: STUN server address : 3478
 TURN server:port: TURN server address : 3478
 TURN user:pass: Turn user name : pass

Outbound Proxy Settings

Registering via an Outbound Proxy

To register an **X-205** device to a SIP Server or SIP Provider with an Outbound Proxy, follow the steps below.

STEP 1	Change the drop down for "SIP Registration Routing" to "REGISTER via Proxy".
STEP 2	Enter the Phone Number (or SIP extension name), SIP Password, Authentication ID (if required), and the IP Address/URL of the SIP Server.
STEP 3	Enter the Outbound Proxy IP Address/URL.
STEP 4	Enter the SIP port that will be used (this port could differ between the SIP Domain and Outbound Proxy), if this is blank port 5060 will be used.
STEP 5	The default SIP protocol is UDP, if TLS or Secure RTP is to be used, change this setting on the VoIP-Security page.

VIKING

Home Basic **VoIP** Admin Status Configure Stream

Account Settings

Phone Number/UserID: 17158675209
 Authentication ID: 15992253021
 Authenticated Password: 6DL34SWq
 Caller ID: 7158675209 RC
 Registrar:port: sip.ringcentral.com : 5060
 Primary proxy:port: sip20.ringcentral.com : 5090
 Secondary proxy:port: secondary.proxyserver.n : 5060
 Local port: 5060
 SIP Registration Expiry: 1800
 SIP Registration Routing: REGISTER via Proxy
 ICE: Disable
 STUN: Disable
 TURN: Disable
 STUN server:port: STUN server address : 3478
 TURN server:port: TURN server address : 3478
 TURN user:pass: Turn user name : pass

11 - Configuring Peer to Peer (Self-Registration)

The **X-205** can be set up to make SIP calls without a SIP Server. To enable this feature enter "127.0.0.1" as the "Registrar" and set a "Phone Number/User ID" (this can be any letter/digit combination). This string must be dialed along with the IP Address of the **X-205** device to make an Inbound call.

For example, to call the **X-205** devices shown right, a SIP endpoint would dial "x35@192.168.0.11" where "192.168.0.11" is the IP Address of the X-Series device.

The screenshot shows the VIKING web interface with the 'VoIP' tab selected. The 'Account Settings' page is displayed, featuring a sidebar with 'Account', 'Audio', 'Security', and 'Logout' options. The main content area includes the following fields:

- Phone Number/UserID: x35
- Authentication ID: Auth. ID
- Authenticated Password: SIP Password
- Caller ID: (optional)
- Registrar:port: 127.0.0.1 : 5060
- Primary proxy:port: primary.proxyserver.net : 5060
- Secondary proxy:port: secondary.proxyserver.n : 5060
- Local port: 5060
- SIP Registration Expiry: 1800
- SIP Registration Routing: SIP Registrar (dropdown)
- ICE: Disable (dropdown)
- STUN: Disable (dropdown)
- TURN: Disable (dropdown)
- STUN server:port: STUN server address : 3478
- TURN server:port: TURN server address : 3478
- TURN user:pass: Turn user name : pass

Peer to Peer Speed Dial Numbers

Outbound Peer to Peer calls are made by dialing directly to the IP Address of an endpoint using the "Phone Number" or "Extension Name".

See the screenshot to the right as an example.

The Extension Name is "1000" and the IP Address of the SIP Endpoint to be called is "192.168.0.10".

The screenshot shows the VIKING web interface with the 'Configure Phone' tab selected. The 'Phone Settings' page is displayed, featuring a sidebar with 'Phone', 'Advanced phone', 'Announcement', 'Relay', 'Network', 'Diagnostics', and 'Logout' options. The main content area includes the following fields:

- Speed Dial Numbers: 1000@192.168.0.10 (highlighted with a red box)
- Access Code: 123456
- Auto Answer: Enabled (dropdown)
- Call Time(0-999s): 180
- Inbound Call Time(0-999s): 180
- Ring Timeout: 30
- Loud Ring: Disabled (dropdown)
- Ring Volume(0-99): 12
- Speaker Volume(0-99): 6
- Mic Volume(0-99): 6
- Use Call Progress: Disabled (dropdown)
- Lap Counter(0-99): 7
- Redial on Busy: Enabled (dropdown)
- LED Mode: Entry Phc (dropdown)
- Alarm Mute: Enabled (dropdown)

12 - Configuring NVR Streaming

The **X-205** video can be streamed to an Onvif compliant NVR. This can be a hardware device, or a PC application. Either configuration will likely require hard drive storage on a PC or a cloud server. Below is a walkthrough using a Lorex NVR with the **X-205**.

STEP 1	Open the NVR user interface after installation.
STEP 2	Click on the "Camera" button.
STEP 3	Click on "Device Search" or "Manual Add".
STEP 4	Find your X-205 and click on it.
STEP 5	Enter the username and password for NVR control and click on Setup.
STEP 6	After the connection is established (you will see confirmation of the successful setup).
STEP 7	If the video is properly displayed, click on Save. The X-205 should show up as a connected device.

ONVIF Streaming Configuration

Setting	Value
HTTP Port	8080
RTSP Port	554
Default Name	X-205 or X-205-EWP

The table above is for Software Based NVR.

The **X-205** has two default accounts for Onvif NVR interaction, shown right. These can be modified or removed via your Onvif NVR interface. Additional users can also be added in the same way. Use either of these for first time NVR configuration.

Username: admin
Password: admin!

Username: operator
Password: operator!

A. Hardware Based NVR

Configure your **X-205** device with a hardware based NVR as shown in the following steps. The screenshots are taken from a Lorex N843 series NVR. Most hardware Network Video Recorders will interact with Onvif cameras in the same fashion, and the interfaces are similar.

The **X-205** device should be connected to the same LAN as the NVR. Take note of the device's IP address (found in the **X-Series Discovery Utility** or in the NVR's search window).

Log in to the Local or Web interface of your NVR with the admin username and password. You should see a screen like the one shown right.

Click on "Camera" to modify connected cameras.

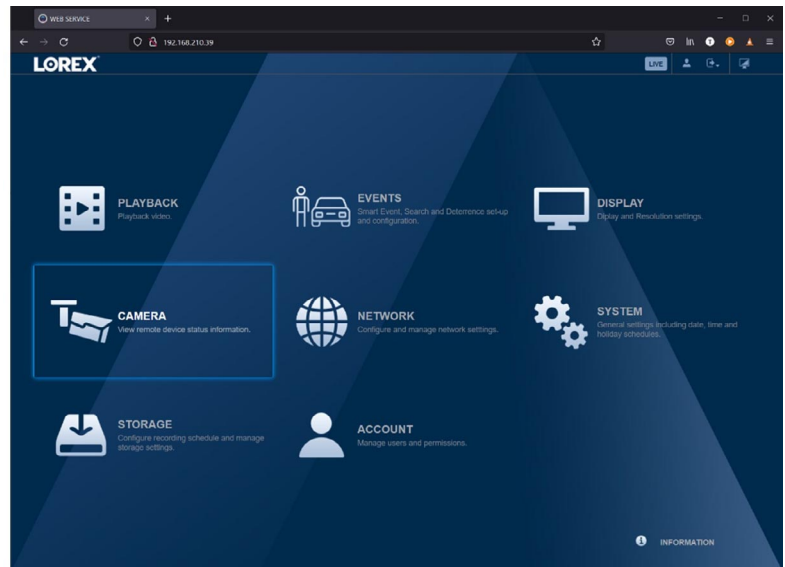

Click on "Manual Add" to add the camera.

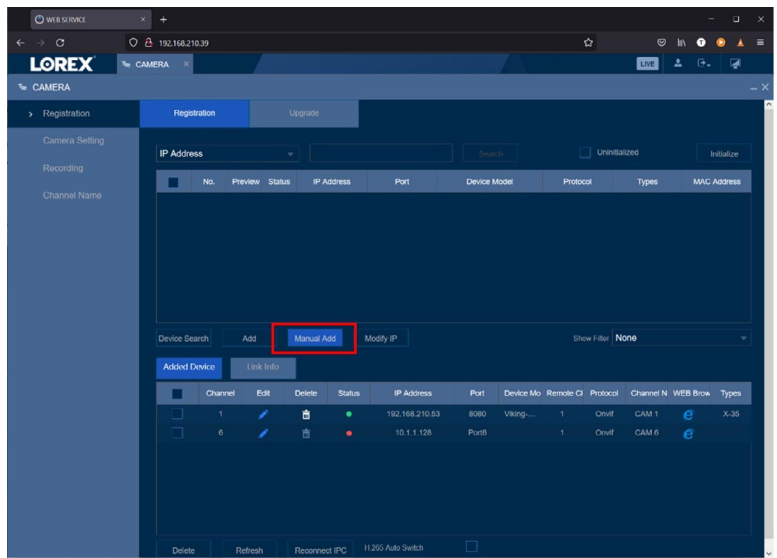

In the pop-up window enter the IP address for your device along with the other values shown below. The default user sets in the **X-205** device are:

Username: admin
Password: admin!

Username: operator
Password: operator!

Click “OK” when finished.

These are intended for default access only and should be changed with the NVR/NVT management software or via the web UI.

See the **Onvif User Management** section for information on adding users.

The screenshot shows an 'Edit' configuration window with the following fields and values:

- Camera: 2
- Protocol: Onvif
- IP Address: 192.168.210.88
- RTSPMode: Self-adaption
- HTTP Port: 8080 (range: 1-65535)
- Username: admin
- Password: masked with dots
- Channel No: 1
- Remote Channel: 1
- Decoder Buffer: Default
- Encrypt:
- Server Type: Auto, TCP, UDP, MULTICAST

Buttons: Setup, OK, Cancel

Within a few seconds the circle next to your device in the “Added Devices” window should turn green as shown to the right.

If the circle stays red, check your credentials, and click on “Reconnect IPC” to renegotiate.

Channel	Edit	Delete	Status	IP Address	Port	Device Mo	Remote Cl	Protocol	Channel N	WEB Brow	Types
1				192.168.210.53	8080	Viking...	1	Onvif	CAM 1		X-35
2				192.168.210.88	8080		1	Onvif	CAM 2		
6				10.1.1.128	Port6		1	Onvif	CAM 6		

Buttons: Delete, Refresh, Reconnect IPC, H.265 Auto Switch

B. Software Based NVR

Configure your **X-205** device with a software based NVR as shown in the following steps. The screenshots are taken from IP Centcom v4.38.920.0, which is available for free from the Microsoft store or Google Play Store.

After downloading and installing IP Centcom or another Software Based NVR (such as Blue Iris).

The following steps can be used for other software-based NVRs as well.

On the Home screen, click on the “Add” button, as shown to the right.

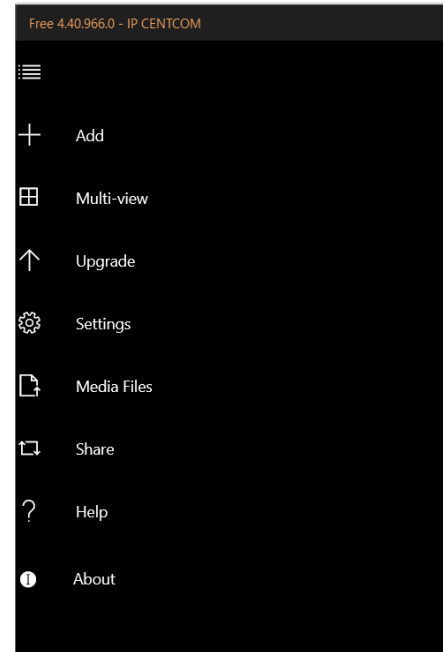

On the next screen, click on the “Discovered” button.

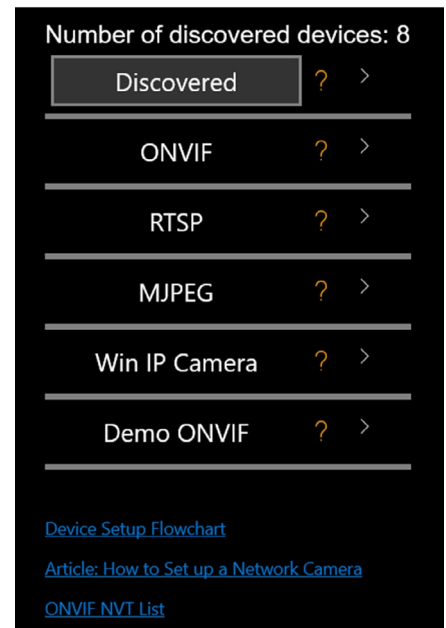

A list of Onvif/streaming devices should be displayed. Select your device from the list and click on it.



You should see a screen like the one to the right. Enter your Username and Password. The default user sets in the **X-205** device are:

Username: admin
Password: admin!

Username: operator
Password: operator!

Click the “Set Up” button.

These are intended for default access only and should be changed with the NVR/NVT management software.

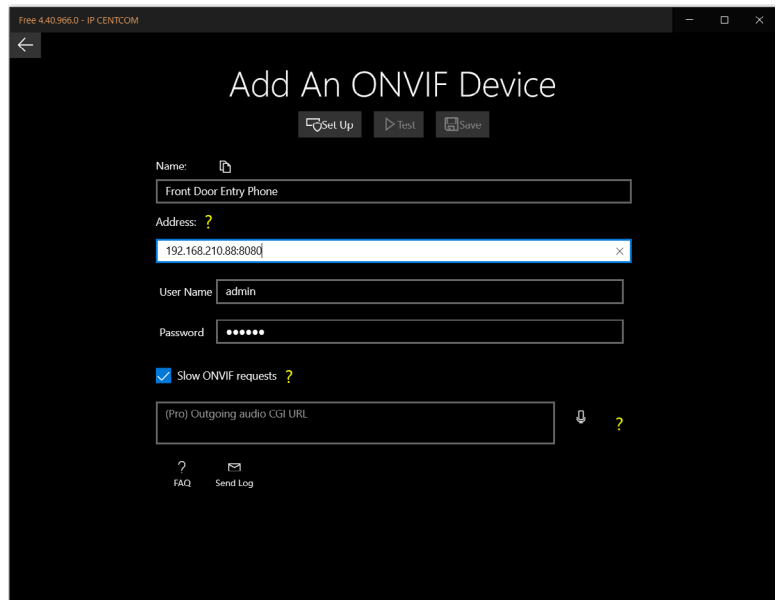

The NVR should connect to the stream and show a confirmation window like the one shown to the right.

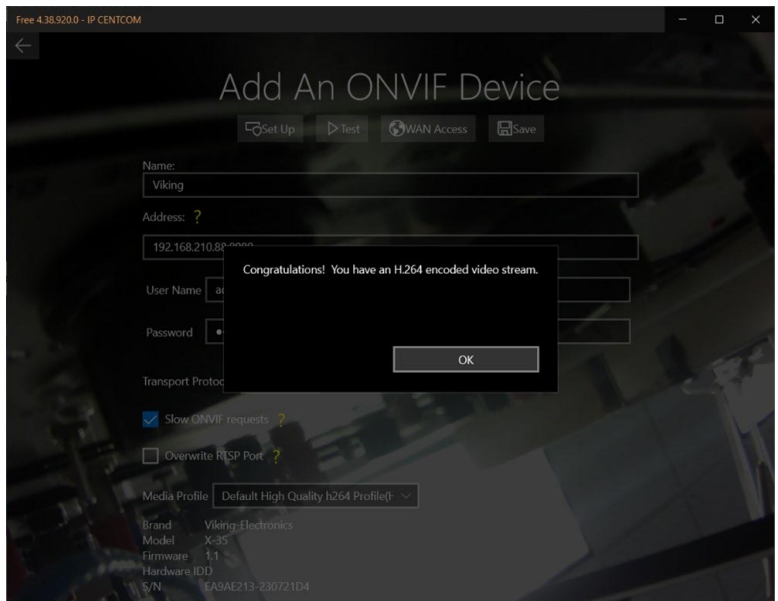

Your image/stream should be displayed in the background as shown on the screen to the right.

If everything looks good, click on the “Save” button. The software will return to the “Home” screen. Click on the “Tile” to view the stream.

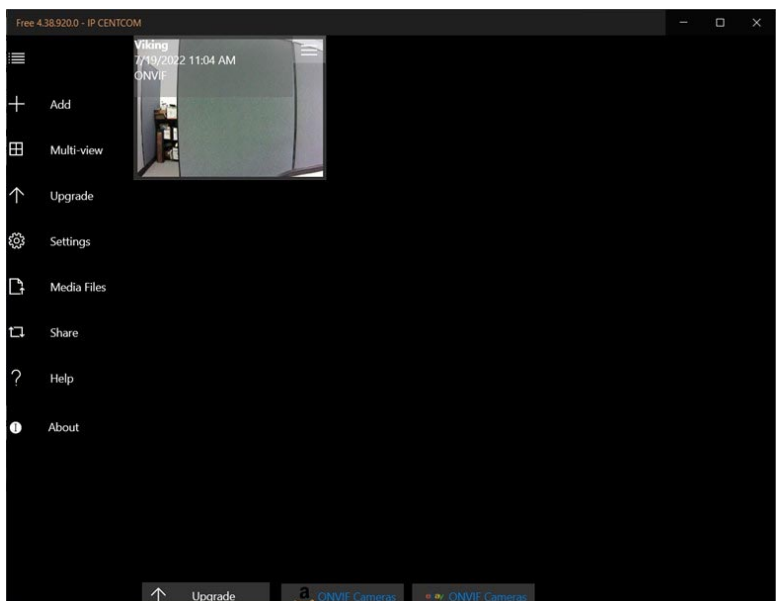

A. Making a Call

When the Call button is pressed, the **X-205** dials the first number in its list. If the call fails (busy, rejected or other SIP call failure) and redial on busy is enabled, the next number will be dialed. If redial on busy is disabled, the **X-205** will hang up and go into its idle state.

Outbound calls will ring until the ring timeout is met, or the call is answered.

When the call is answered, two-way voice is established, and video is sent to the called device. The call timer starts. The called device can enter the relay commands if door strike mode is enabled. Door strike code starts a momentary relay closure, and the latching commands (on code/off code) will latch the relay. The call can be ended with the call button, or remotely with a call ended signal. If neither of these happen, the call timer ends the call when its value is met.

B. Incoming Calls

The **X-35** will handle incoming calls based on the settings below.

Setting	Description	Factory Default								
Auto Answer	The X-35 will automatically answer inbound calls when Auto Answer is set to enabled. Two-way voice is established, and the X-205 sends video to the caller. If the Access Code is set, it must be entered before any relay commands are accepted.	Enabled								
Loud Ring	The X-205 will emit a ring from its speaker when its extension is dialed. The call can be answered by pressing the Call button. The volume of this ringing is controlled with the Loud Ring Volume.	Disabled								
Disabled	If both Auto Answer and Loud Ringing are set to disabled, the X-205 will not accept incoming calls. This is useful for applications where only outbound calls will be allowed. If inbound calls are not required, disable these for more security.	n/a								
Speaker Mode	<p>The speaker mode can be set to one of three modes:</p> <table border="1" style="width: 100%; border-collapse: collapse;"> <thead> <tr> <th style="background-color: #cccccc;">Speaker Mode</th> <th style="background-color: #cccccc;">Description</th> </tr> </thead> <tbody> <tr> <td style="background-color: #cccccc;">On</td> <td>In the "On" mode, the speaker is enabled during inbound and outbound SIP calls.</td> </tr> <tr> <td style="background-color: #cccccc;">Silent Monitor</td> <td>In the "Silent Monitor" mode the speaker is always disabled on both inbound and outbound SIP calls.</td> </tr> <tr> <td style="background-color: #cccccc;">Off Until Answered</td> <td>In the "Off Until Answered" mode, the speaker will remain silent during dialing and will not turn on until the called party has answered. On inbound calls to the X-205 the speaker will be on for the entire call.</td> </tr> </tbody> </table>	Speaker Mode	Description	On	In the "On" mode, the speaker is enabled during inbound and outbound SIP calls.	Silent Monitor	In the "Silent Monitor" mode the speaker is always disabled on both inbound and outbound SIP calls.	Off Until Answered	In the "Off Until Answered" mode, the speaker will remain silent during dialing and will not turn on until the called party has answered. On inbound calls to the X-205 the speaker will be on for the entire call.	On
Speaker Mode	Description									
On	In the "On" mode, the speaker is enabled during inbound and outbound SIP calls.									
Silent Monitor	In the "Silent Monitor" mode the speaker is always disabled on both inbound and outbound SIP calls.									
Off Until Answered	In the "Off Until Answered" mode, the speaker will remain silent during dialing and will not turn on until the called party has answered. On inbound calls to the X-205 the speaker will be on for the entire call.									

14 - SIP Endpoint Configuration

Configuring SIP Video Endpoints:

Linphone Desktop:

Download the Desktop app at:

<https://www.linphone.org/category-product/windows-desktop>

SIP Registration:

To configure Linphone for a new SIP account, click on Home, then the 'Assistant' button. Then click on the "Use a SIP Account" button.

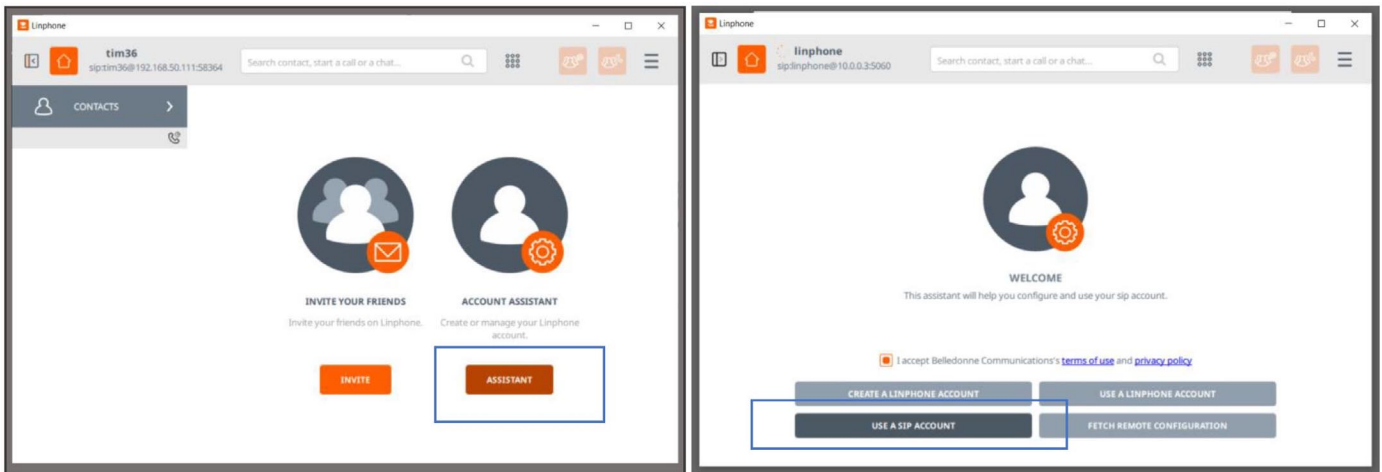

Enter Your SIP Credentials:

Enter your username/extension along with the SIP Server Domain and the account password. Click on the "Use" button. This can be an account from the Linphone free SIP server if the account has been created (or by selecting "Use a Linphone Account").

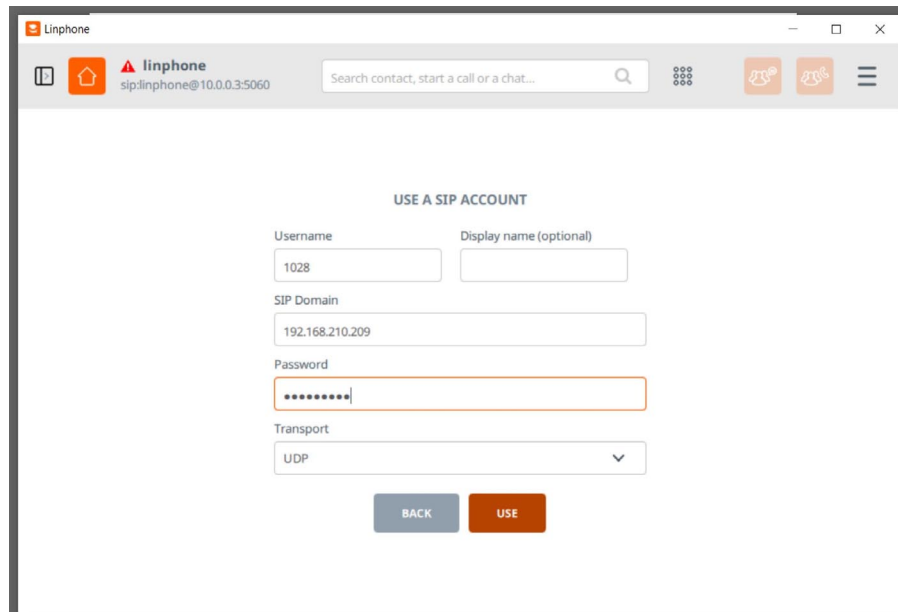

Check for Registration:

If all credentials are correct, the extension name should be shown in the upper left corner with a green checkmark. If not, click on the Account name and change the drop down to available. If your password is incorrect, or the account needs an Authentication ID entered, you will be prompted to enter it in a pop-up window.

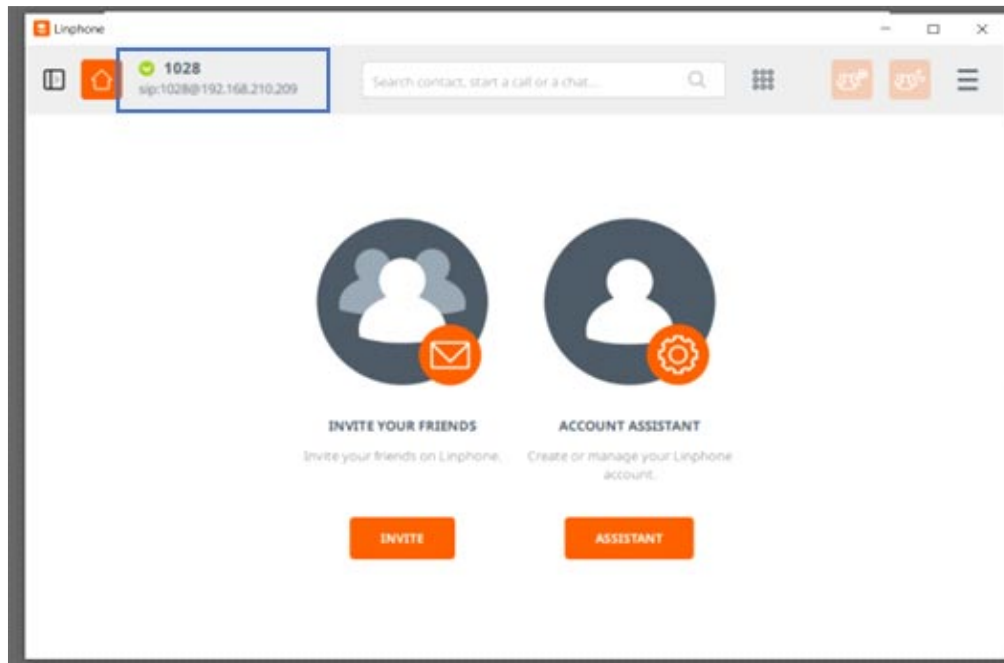

Linphone Settings:

Once the account is registered, check the "Preferences" to make sure Video/SIP settings are correct.

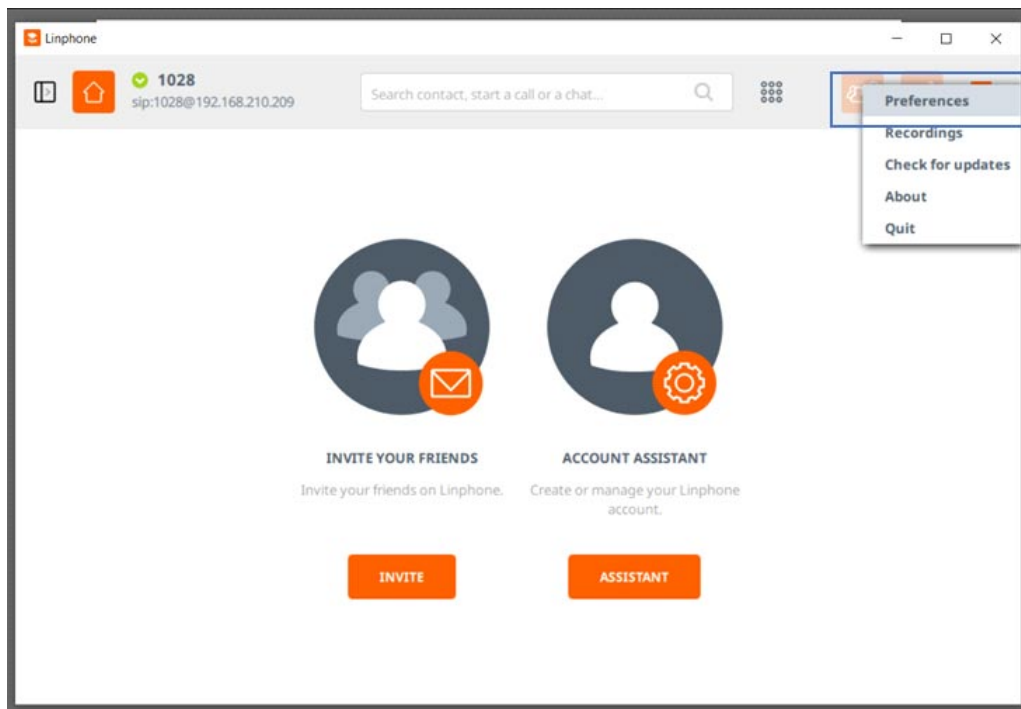

Under the Video settings, the “Status” of the H264 encoder should be enabled as shown below. The Profile-level-id field controls what video quality Linphone will request on SIP video calls.

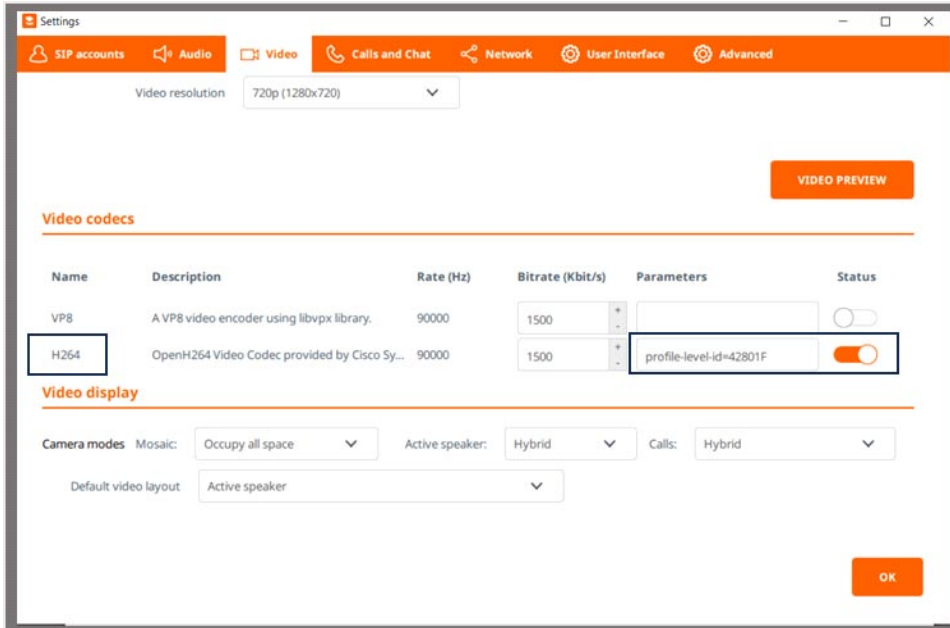

Under the network tab, check that your ports for audio and video are configured correctly.

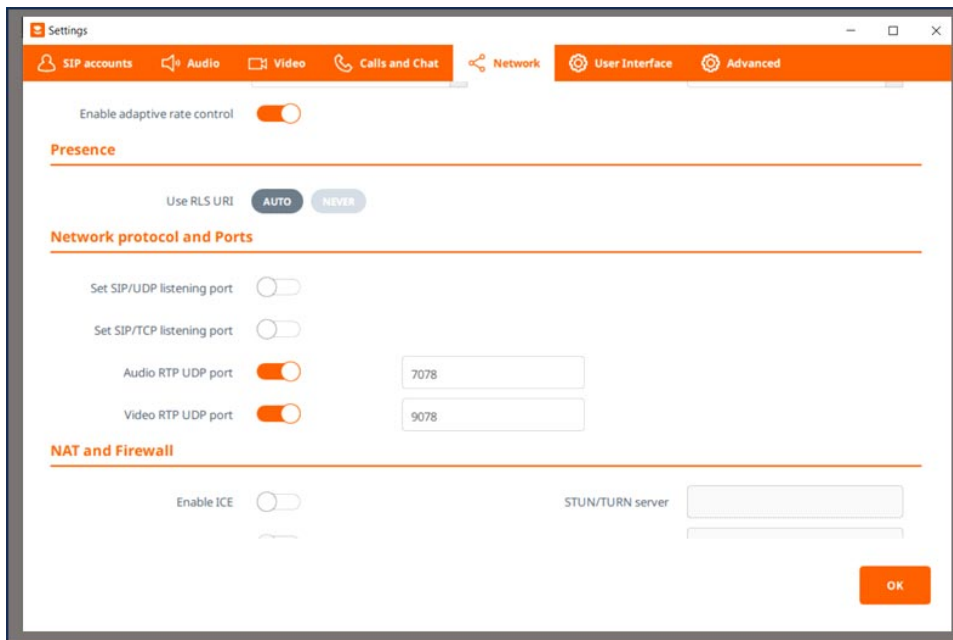

Peer-to-Peer calls with Linnphone:

Your Linnphone app contains a 'Default Identity' which it uses for Peer-to-Peer SIP calls. For example, the app below will use 'tim36@192.168.50.111' to receive and make Peer to Peer calls ('192.168.50.111' is the IP Address of the PC running Linnphone).

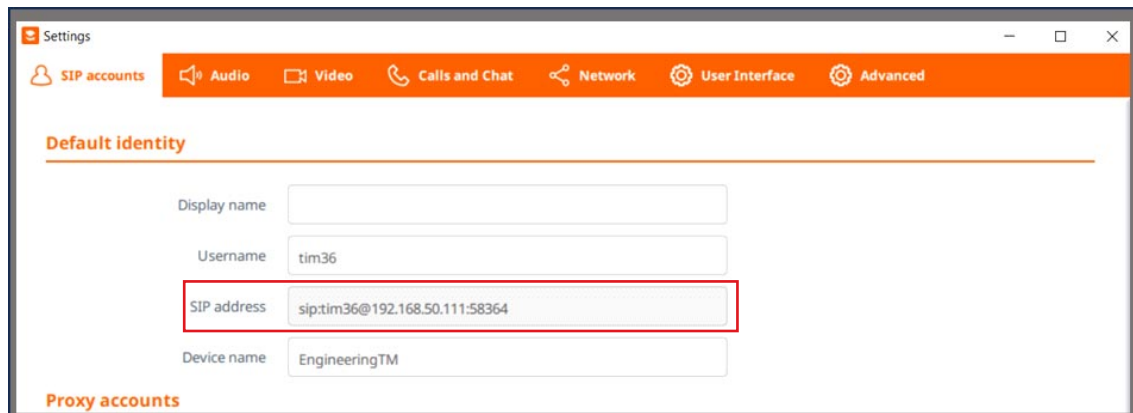

The screenshot shows the 'Settings' window of the Linnphone application. The 'Default identity' section is highlighted with a red box. The fields are as follows:

Field	Value
Display name	
Username	tim36
SIP address	sip:tim36@192.168.50.111:58364
Device name	EngineeringTM

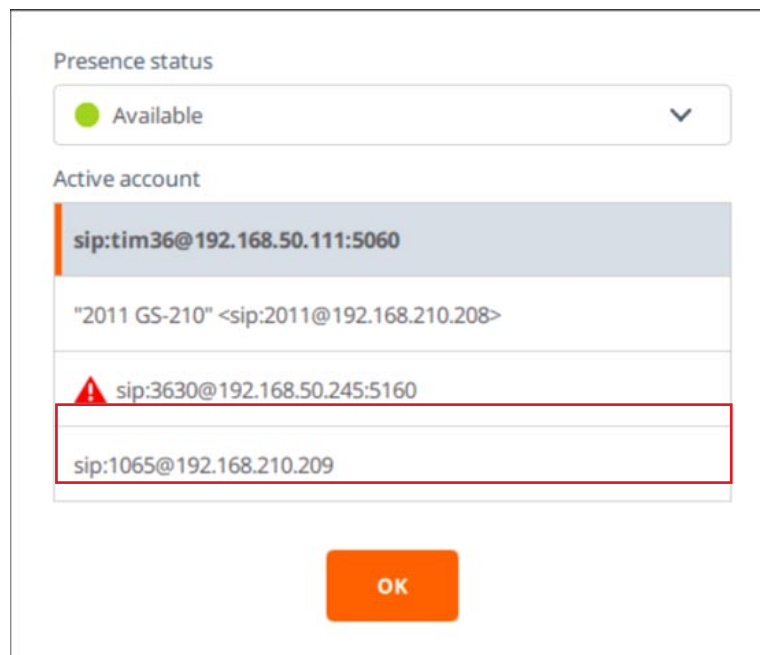

The screenshot shows the 'Active account' dialog box. The 'Presence status' is set to 'Available'. The 'Active account' list contains the following entries:

- sip:tim36@192.168.50.111:5060
- "2011 GS-210" <sip:2011@192.168.210.208>
- sip:3630@192.168.50.245:5160
- sip:1065@192.168.210.209

The 'sip:1065@192.168.210.209' entry is highlighted with a red box. An 'OK' button is located at the bottom of the dialog.

X-Series outbound calls to Linphone in Peer-to-Peer mode:

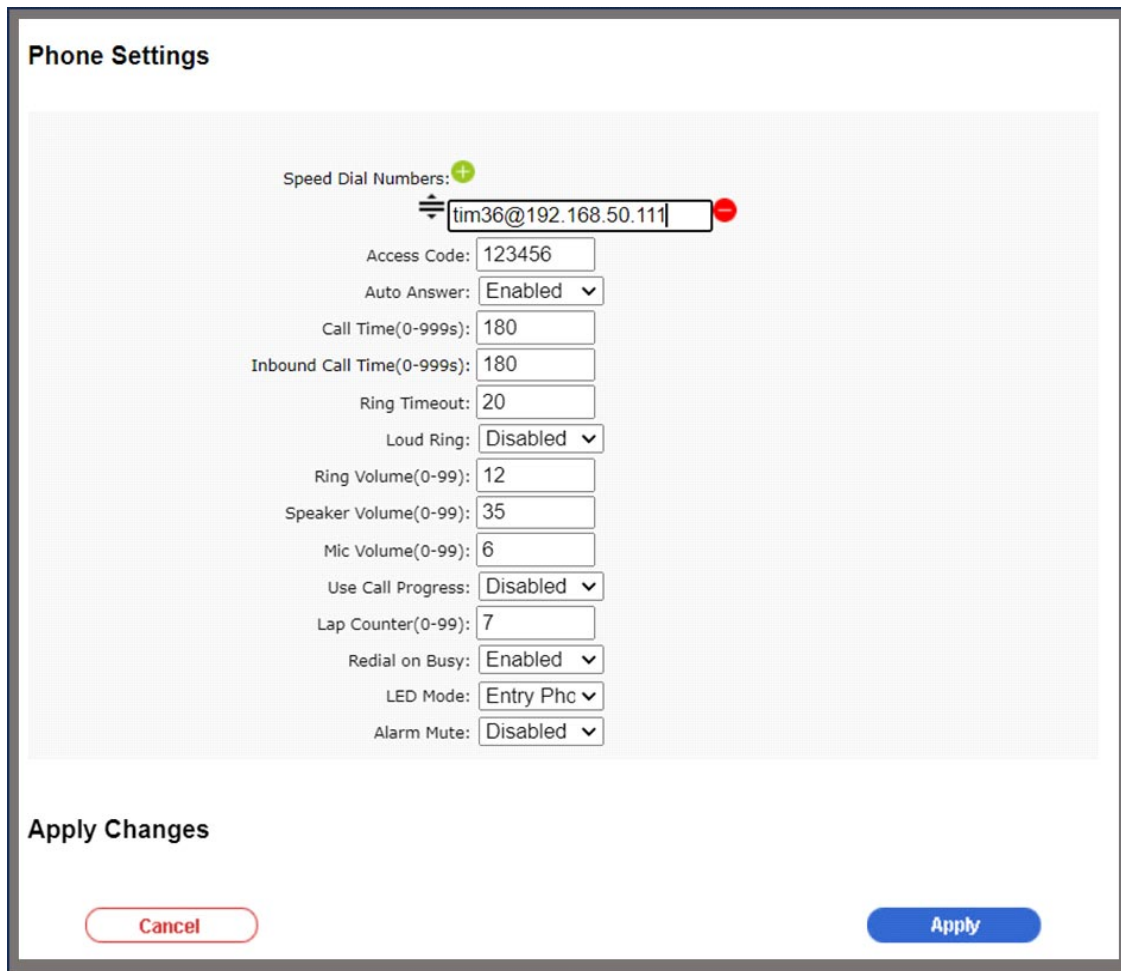

Phone Settings

Speed Dial Numbers: +

-

Access Code:

Auto Answer: ▼

Call Time(0-999s):

Inbound Call Time(0-999s):

Ring Timeout:

Loud Ring: ▼

Ring Volume(0-99):

Speaker Volume(0-99):

Mic Volume(0-99):

Use Call Progress: ▼

Lap Counter(0-99):

Redial on Busy: ▼

LED Mode: ▼

Alarm Mute: ▼

Apply Changes

With the above 'Speed Dial Number', when the Call button is pressed the X-Series Intercom will call the PC running Linphone at 'tim36@192.168.50.111'.

FreePBX Setup with Viking Video Intercoms:

Global Settings:

Set up your extensions as 'chan_sip (legacy)'.

Be sure to Set Video to Enabled, and make sure h264 and mpeg4 are selected.

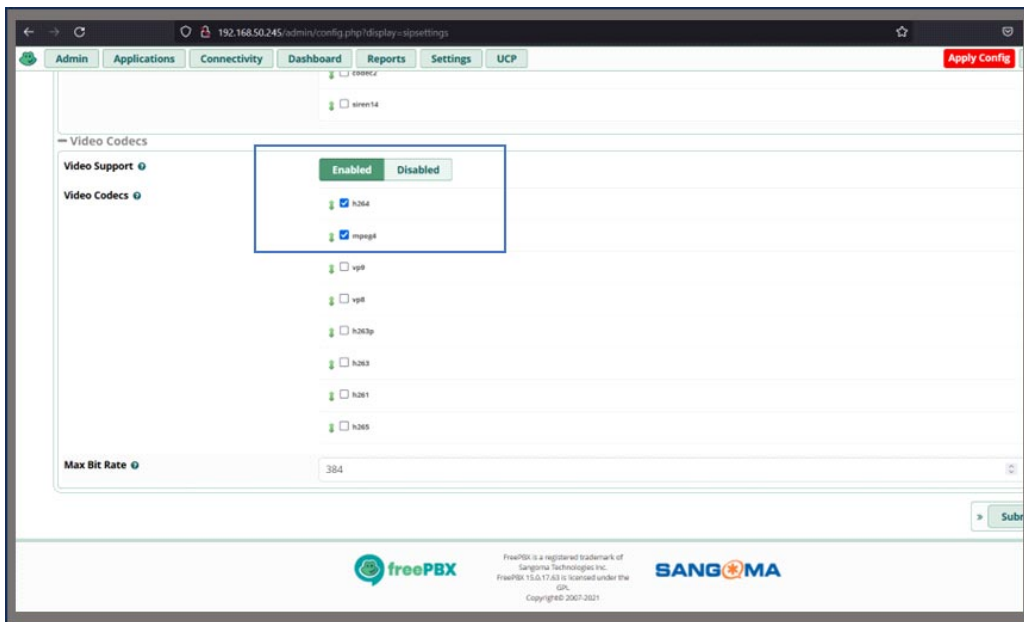

Under Applications-Extensions, edit the extension. Under Advanced set the "Allowed Codec" field to h264 and submit, then apply changes.

Extension Settings:

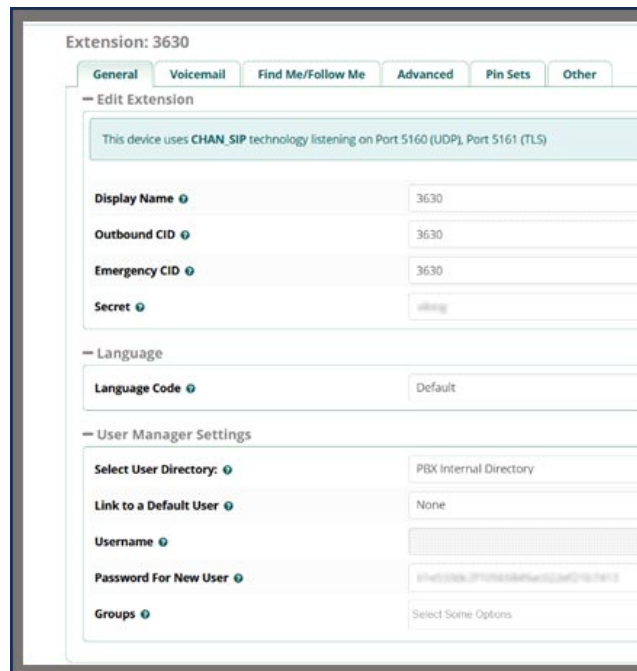

Configuring the X-Series Intercom for FreePBX:

Be sure to select the proper port (5160 below).

If your FreePBX install is on a local machine, you will likely use the 'SIP Registrar' setting (default).

If your FreePBX install is on a cloud server, you may need to 'Register Via Proxy'. If so, use the drop down to select the proxy option, and enter the proxy address as the 'Primary proxy' Be sure to include the port.

The screenshot shows the 'Account Settings' page for a VIKING device. The page has a red header with the 'VIKING' logo and navigation tabs for Home, Basic, VoIP, Admin, Status, Configure, and Stream. A left sidebar contains a menu with 'Account', 'Audio', 'Security', and 'Logout'. The main content area is titled 'Account Settings' and contains various configuration fields. The 'Registrar:port' field is highlighted with a red box and contains the value '5160'. Other fields include Phone Number/UserID (3630), Authentication ID (Auth. ID), Authenticated Password (viking), Caller ID (optional), Primary proxy:port (primary.proxysvr.net : 5060), Secondary proxy:port (secondary.proxysvr.net : 5060), Local port (5060), SIP Registration Expiry (1800), SIP Registration Routing (SIP Registrar), ICE (Disable), STUN (Disable), and TURN (Disable). Below the fields are buttons for 'Cancel' and 'Apply'. At the bottom, there is a copyright notice: © 2023 Viking Electronics X-35 Product Manual and the ONVIF logo.

Phone Number/UserID	3630
Authentication ID	Auth. ID
Authenticated Password	viking
Caller ID	(optional)
Registrar:port	192.168.50.243 : 5160
Primary proxy:port	primary.proxysvr.net : 5060
Secondary proxy:port	secondary.proxysvr.net : 5060
Local port	5060
SIP Registration Expiry	1800
SIP Registration Routing	SIP Registrar
ICE	Disable
STUN	Disable
TURN	Disable
STUN server:port	STUN server address : 3478
TURN server:port	TURN server address : 3478
TURN user:pass	Turn user name : pass

Apply Changes

Cancel Apply

© 2023 Viking Electronics
X-35 Product Manual

ONVIF®

Peer to Peer dialing (outbound calls):

On the X-series device, set the Speed Dial number to the Yealink phone's 'Username@IPAddress' like the image below.

Important Configuration items in this example:

Yealink Phone's IP Address: 192.168.50.17

Yealink Phone's SIP Username: 106

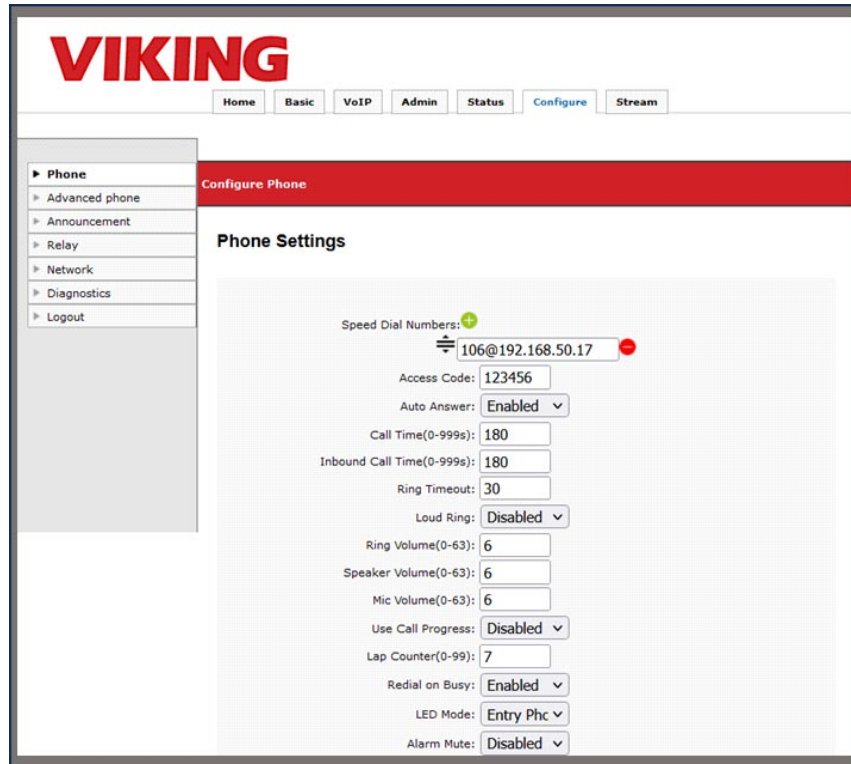

The screenshot displays the VIKING web interface for configuring a phone. The top navigation bar includes 'Home', 'Basic', 'VoIP', 'Admin', 'Status', 'Configure', and 'Stream'. The 'Configure' tab is active, and the 'Phone' section is selected in the left sidebar. The main content area is titled 'Configure Phone' and 'Phone Settings'. The 'Speed Dial Numbers' section is highlighted, showing a single entry with the value '106@192.168.50.17'. Below this, various settings are listed, including 'Access Code' (123456), 'Auto Answer' (Enabled), 'Call Time(0-999s)' (180), 'Inbound Call Time(0-999s)' (180), 'Ring Timeout' (30), 'Loud Ring' (Disabled), 'Ring Volume(0-63)' (6), 'Speaker Volume(0-63)' (6), 'Mic Volume(0-63)' (6), 'Use Call Progress' (Disabled), 'Lap Counter(0-99)' (7), 'Redial on Busy' (Enabled), 'LED Mode' (Entry Phc), and 'Alarm Mute' (Disabled).

Setting	Value
Speed Dial Numbers	106@192.168.50.17
Access Code	123456
Auto Answer	Enabled
Call Time(0-999s)	180
Inbound Call Time(0-999s)	180
Ring Timeout	30
Loud Ring	Disabled
Ring Volume(0-63)	6
Speaker Volume(0-63)	6
Mic Volume(0-63)	6
Use Call Progress	Disabled
Lap Counter(0-99)	7
Redial on Busy	Enabled
LED Mode	Entry Phc
Alarm Mute	Disabled

Grandstream:

Be sure to check the box to Support SIP Video for Grandstream 6200 and 6400 series PBX.

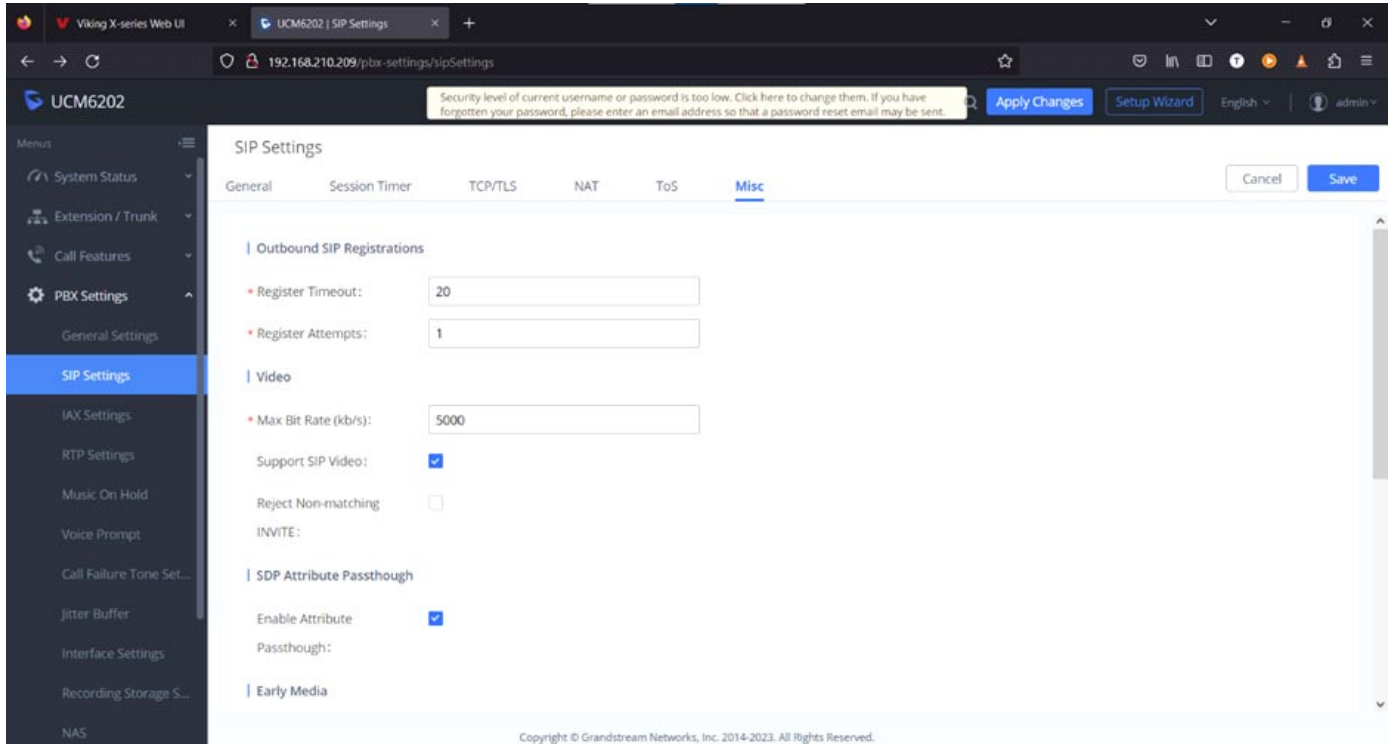

D-Link Router Configuration:

Some routers use 'Application Level Gateway' (ALG) Settings for SIP and RTSP. Disable ALG on your router if it is enabled. See the image below (from a D-Link Router):

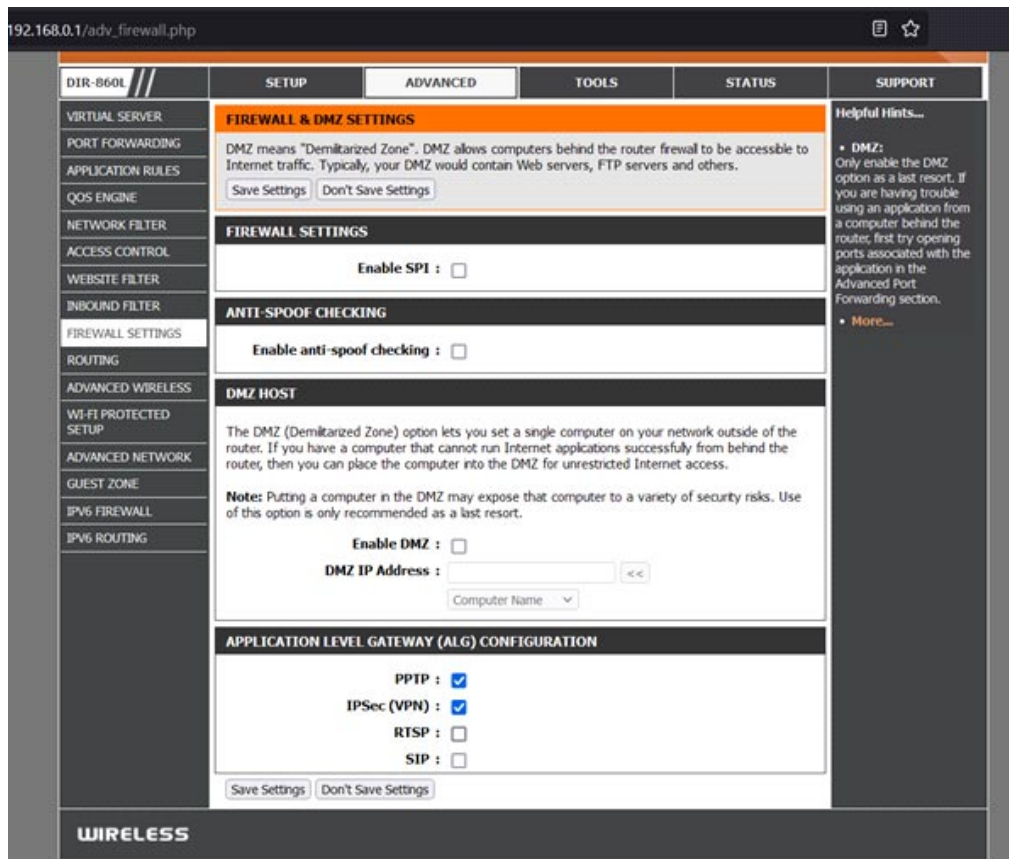

H264 Profile Level ID:

Here's a visual breakdown of the "profile-level-id" parameter for a 1080p call:

Profile-Level-ID: | Profile | Compatibility | Level |
 | 42 | 80 | 2A |

In Linphone Desktop, see the Preferences->Audio->H264



For X-Series devices, we will always use '4280xx' where 'xx' will determine the resolution and framerate. Acceptable values are shown below:

Profile-level-id value	Resolution	Framerate
42802A	1920x1080	Up to 30 FPS
42801F	720x576	Up to 30 FPS
42801D	352x288	Up to 30 FPS

The "profile-level-id" is a parameter used to specify the H.264 profile and level for encoding and decoding video streams. It is typically communicated in the Session Initiation Protocol (SIP) signaling for video calls, allowing endpoints to understand the video codec settings used during the call. The "profile-level-id" is a hexadecimal string that provides information about the H.264 profile and level being used. It's usually a 16-character string, and you can break it down into three separate fields:

1. Profile (2 characters):

The first two characters of the "profile-level-id" represent the H.264 profile. H.264 supports different profiles, each with varying levels of compression and capabilities.

Common profiles include:

- 42 for Baseline Profile
- 4D for Main Profile
- 64 for High Profile

2. Compatibility (2 characters):

The next two characters represent compatibility flags. These flags provide additional information about the codec's features and capabilities, such as the use of certain tools or extensions. These flags are not as commonly used as profiles and levels and are often set to 00 for baseline H.264 video.

3. Level (2 characters):

The last two characters specify the H.264 level. Levels define constraints on the video codec, including maximum resolution, bit rate, and other parameters. The value represents a level such as:

- 1E for Level 1.0
- 3E for Level 3.0
- 4D for Level 4.0

So, for example, if you see a "profile-level-id" of "42801F," it can be broken down as follows:

Profile: "42" (Baseline Profile)

Compatibility: "80"

Level: "1F" (Level 1.0) (720p)

This breakdown helps endpoints in a SIP video call negotiate and understand the H.264 video settings being used, ensuring that both sides of the call are compatible and can decode the video stream correctly.

15 - Configuring Mobile Application Endpoints

Suggested Android Apps:

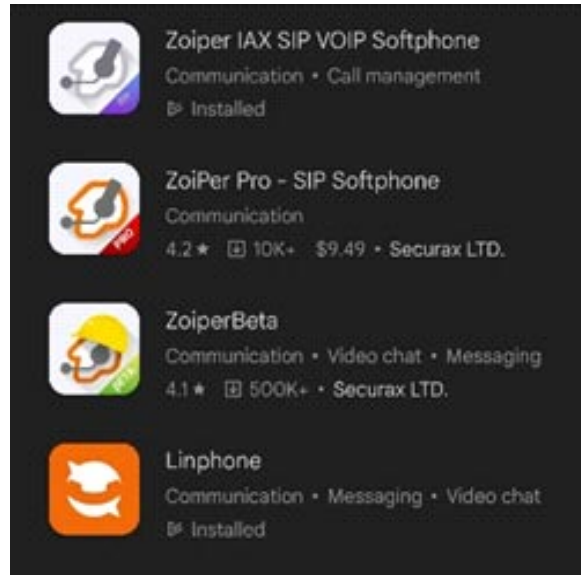

Any of the Zoiper versions are compatible with SIP Video calls to and from the X-Series Devices. Linphone is a free option that works also, is compatible and works well for SIP Video calls.

Zoiper

Zoiper is a SIP softphone application that is available in the Play Store. The 'Combo' pack is \$0.99 per month to use the h.264 video codec (required for video calls).

Video calls can be made using a SIP Server, SIP Provider, or using our 'Peer to Peer' calling mode.

After downloading Zoiper, make sure h.264 is selected in the settings.

Under Settings->Accounts, click on your SIP Account and scroll down to modify the 'Video Codec Settings'.

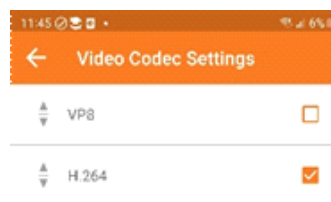

SIP Server/SIP Provider Configuration:

Register the Zoiper Android app to the same SIP Server/Provider that your X-Series Device is registered to. When your credentials are entered correctly, the SIP account should be shown in the list of accounts with a green checkmark.

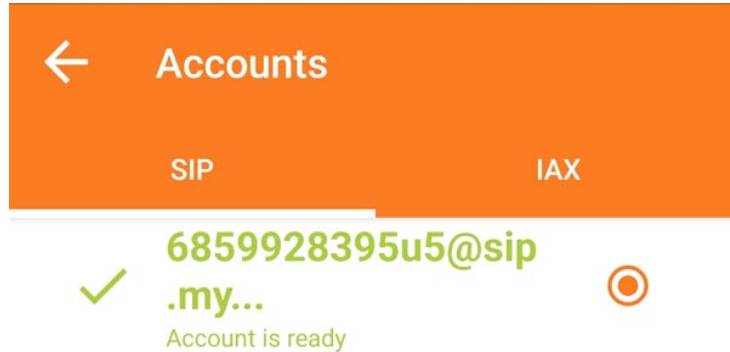

Calls to Zoiper from the X-Series Device:

Enter the **SIP Username** in the **Speed Dial Numbers** field on your **X-Series Device**. When the **Call Button** is pressed the **X-Series Device** will call Zoiper's SIP Extension.

Note: If the domain is not included calls will still work, they will use the domain the **X-Series Device** is registered to.

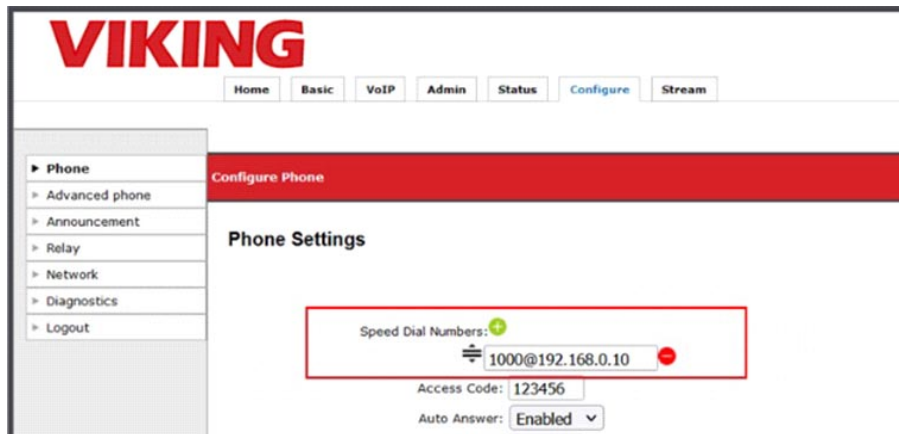

Calling Into the X-Series Device:

The **X-Series Device** can be called by clicking the 'Dialpad' icon and then entering the SIP Extension of the **X-Series Device**. For quicker dialing, the **X-Series Device** can be added as a 'Contact'.



Enter Extension Here

-Or-

Open Dialpad Here

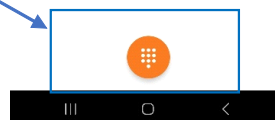
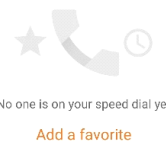

Linphone Android Application

Linphone is a SIP softphone application that is available in the Play Store. This is a free application built on open-source software. There is an Android SDK available for customizing the Softphone Application. Video calls can be made using a SIP Server, SIP Provider, or using our 'Peer to Peer' calling mode. After downloading Linphone, make sure h.264 is selected in the settings.

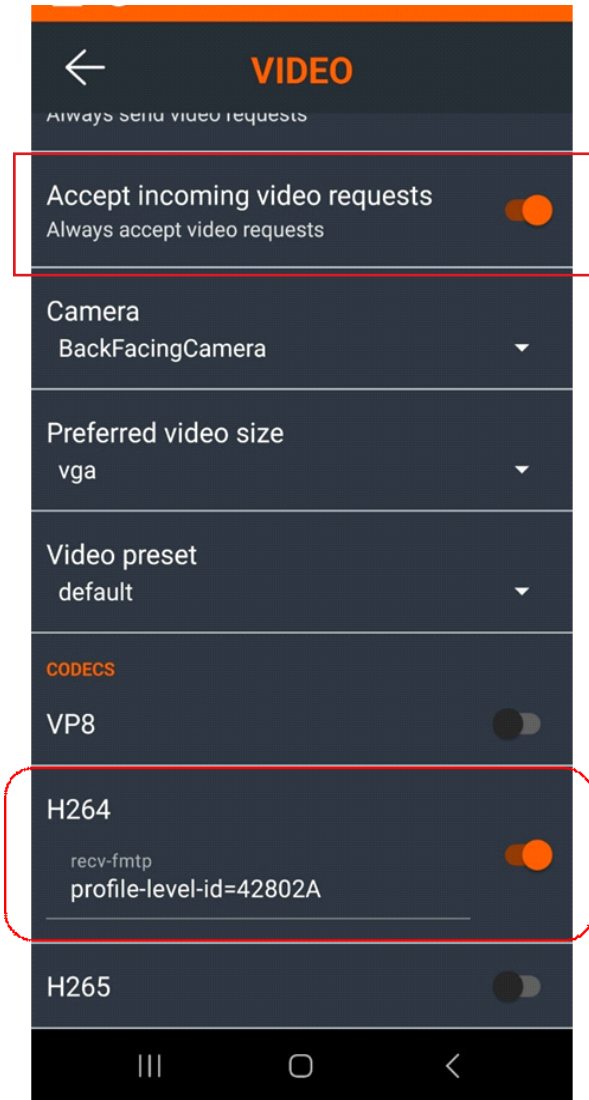

Enable this setting to display video automatically when a call is answered.

SIP Server/SIP Provider Configuration:

Register the Linphone Android app to the same SIP Server/Provider that your X-Series Device is registered to. On the top left of the Linphone screen click on the 3-lines-button, then click 'Assistant'.

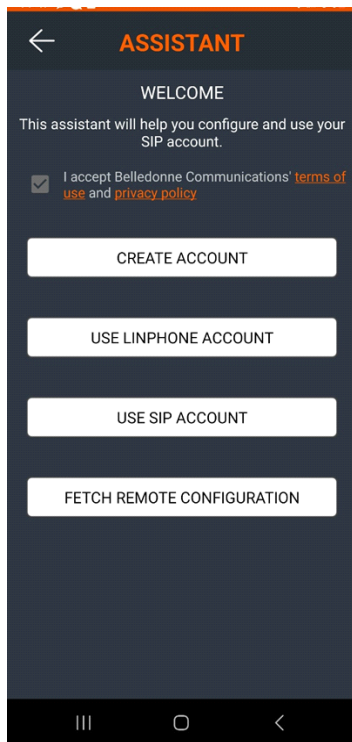

Select the proper option (most likely 'Use a SIP Account').

Enter your SIP Server/Provider Account credentials and click the 'LOGIN' button.

If your registration is successful, a green circle will be shown next to the account on the Home page.

Calls to Linphone from the X-Series Device:

Enter the **SIP Username** in the **Speed Dial Numbers** field on your **X-Series Device**.

When the **Call Button** is pressed the **X-Series Device** will call **Linphone** SIP Extension.

Note: If the domain is not included calls will still work, they will use the domain the **X-Series Device** is registered to.

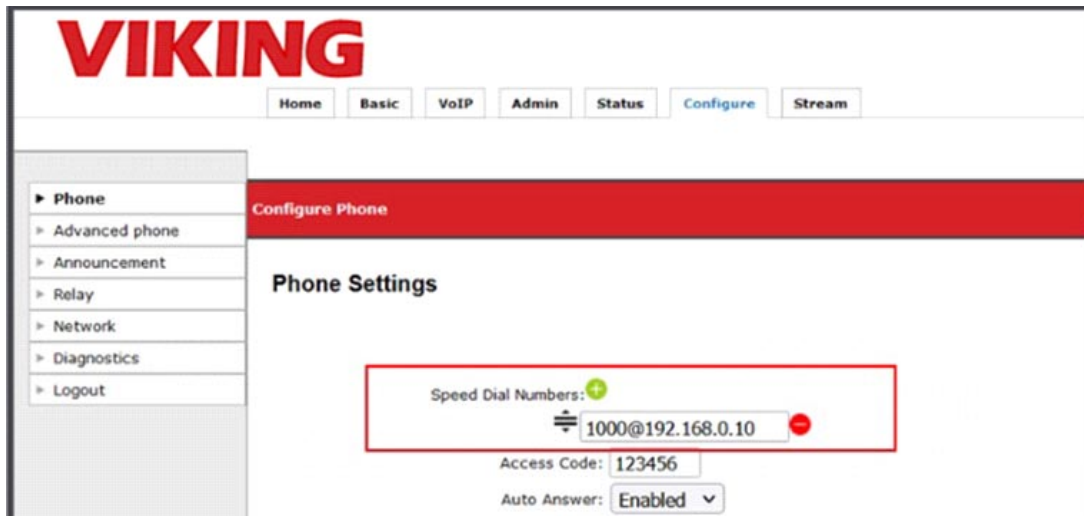

Calling Into the X-Series Device:

The **X-Series Device** can be called by clicking the 'Dialpad' icon and then entering the SIP Extension of the **X-Series Device**. For quicker dialing, the **X-Series Device** can be added as a 'Contact'.

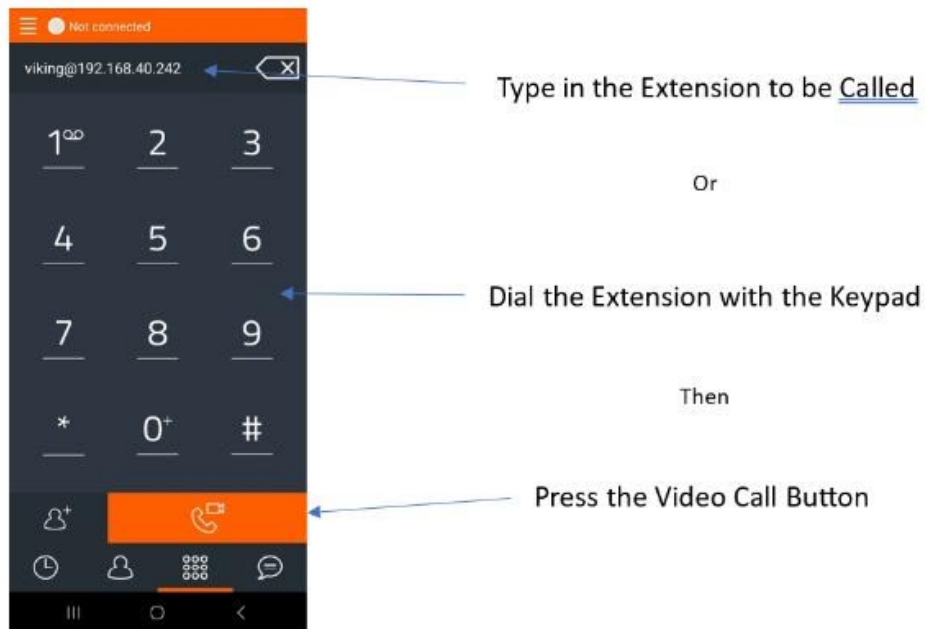

16 - Linphone SIP Service

Using Linphone's public SIP server with X-Series Intercoms:

When a Linphone account is created a SIP account on their public SIP server is created. This does require entering a valid email address.

Creating a Linphone account online:

Go to <https://subscribe.linphone.org> and click on 'Create an Account'.

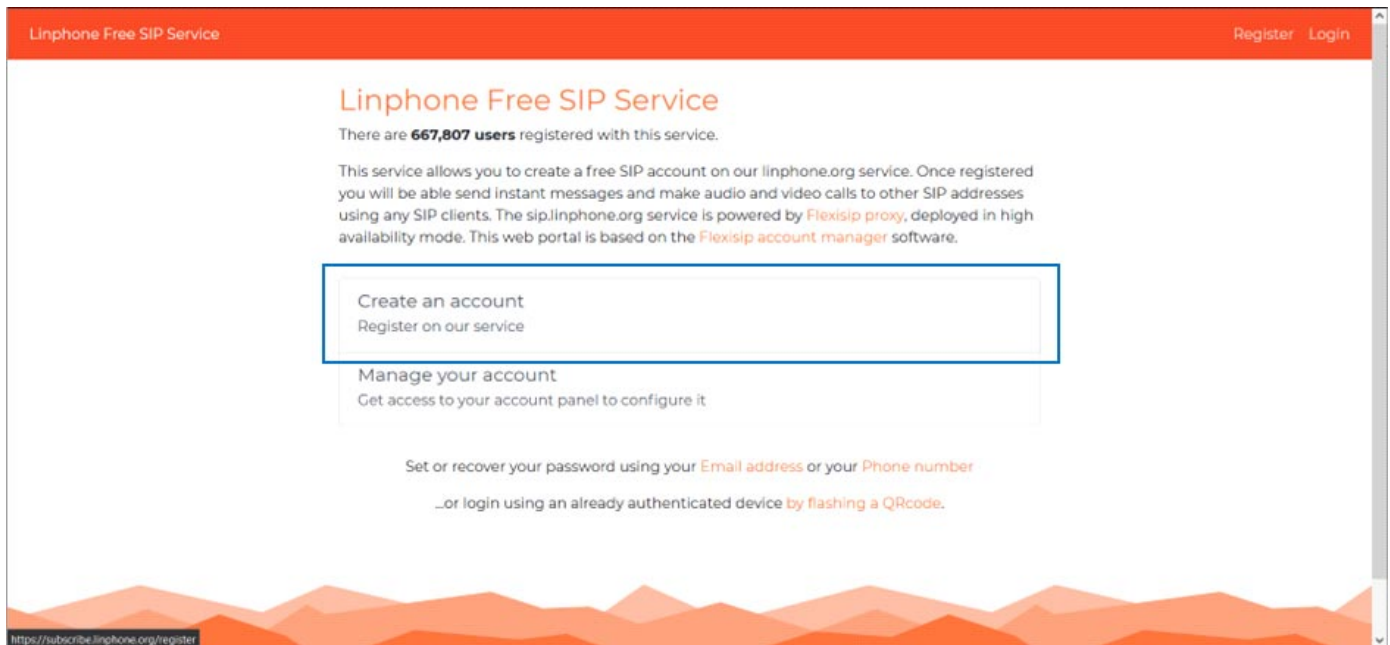

Next click on 'Using Your Email Address'.

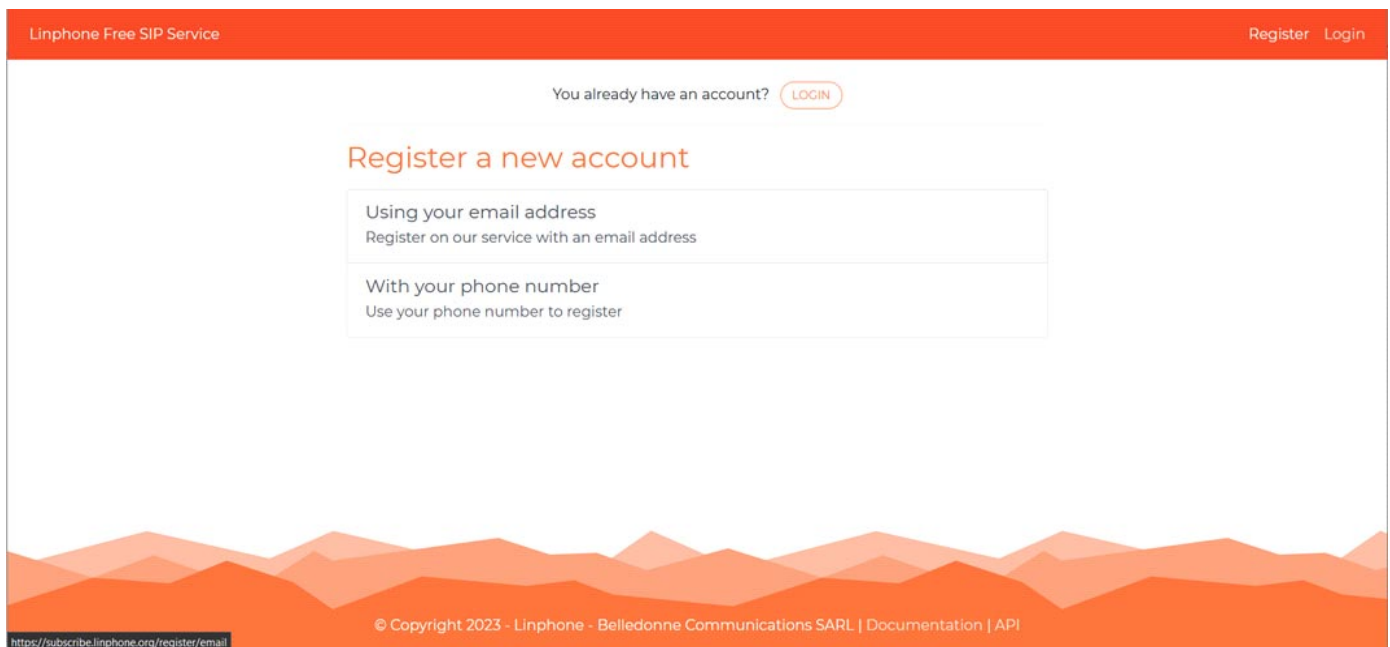

Enter a SIP Username. This is the 'Extension' name that will be used to make calls. In the screenshot below, to call this account another user would dial 'vikingfrontdoor'. Check the boxes for the terms click 'Register'.

Linphone Free SIP Service Register Login

Register using an email address

Fill a username and an email address, you will then be able to set a password to finish the registration process.

SIP Username
vikingfrontdoor @sip.linphone.org
Shouldn't be a phone number. Capital letters are not allowed.

Email demo@example.net **Email confirmation** demo@example.net

I would like to subscribe to the newsletter

I accept the **Terms and Conditions:**
[Read the Terms and Conditions](#)

I accept the **Privacy policy:**
[Read the Privacy policy](#)

I'm not a robot 

[REGISTER](#)

You will receive a confirmation email. Click the link to set your password (this is also your SIP Password).

Linphone Free SIP Service Logout

Set my account password

New password
.....

Password confirmation
.....

Use a **SHA-256 encrypted password.**
This stronger password might not work with some old SIP clients.

[CHANGE](#)

Configuring the X-Series Intercom with the account:

Log in to the X-Series Web UI and click on the 'VoIP' tab. Enter the SIP Username, Password, and Domain as shown below.

The screenshot shows the VIKING web interface for configuring VoIP settings. The top navigation bar includes 'Home', 'Basic', 'VoIP', 'Admin', 'Status', 'Configure', and 'Stream'. A left sidebar contains 'Account', 'Audio', 'Security', and 'Logout'. The main content area is titled 'VoIP' and 'Account Settings'. It contains a form with the following fields:

Phone Number/UserID	vikingfrontdoor	
Authentication ID	Auth. ID	
Authenticated Password	LinphonePassword	
Caller ID	(optional)	
Registrar:port	sip.linphone.org	: 5060
Primary proxy:port	primary.proxysvr.net	: 5060
Secondary proxy:port	secondary.proxysvr.net	: 5060
Local port	5060	
SIP Registration Expiry	1800	
SIP Registration Routing	SIP Registrar	
ICE	Disable	
STUN	Disable	
TURN	Disable	
STUN server:port	STUN server address	: 3478
TURN server:port	TURN server address	: 3478
TURN user:pass	Turn user name	: pass

Unit Name: X-35 MAC Address: 18:E8:0F:50:8B:D6

Apply Changes

Cancel Apply

Configure the Speed Dial Number(s) in the X-Series Intercom:

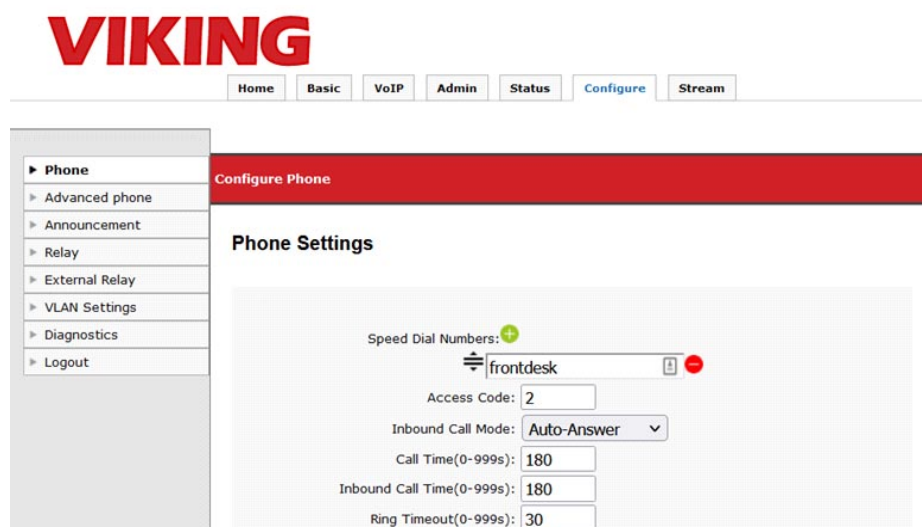

This is considering you have another Linphone account registered to 'frontdesk@sip.linphone.org'. When the button is pressed the X-Series Intercom will dial 'frontdesk@sip.linphone.org'.

Making SIP Video Calls:

You will need another SIP endpoint to make and receive calls with the X-Series Intercom. The next section shows how to configure the Linphone Desktop application to use the public Linphone SIP service.

Other SIP endpoints such as Zoiper/Zoiper Pro can also be used. The SIP Username, SIP Password and domain will be entered to register (domain is 'sip.linphone.org').

Configuring a Second SIP Endpoint to Register with Linphone:

A second Linphone account can be created within Linphone Desktop or Linphone mobile (Android/IOS). You can also register for a second Linphone account online and use it (this is the only option with the mobile apps).

Download Linphone Desktop from:

<https://www.linphone.org/category-product/windows-desktop>

Click on the 'Assistant' button to create an account.

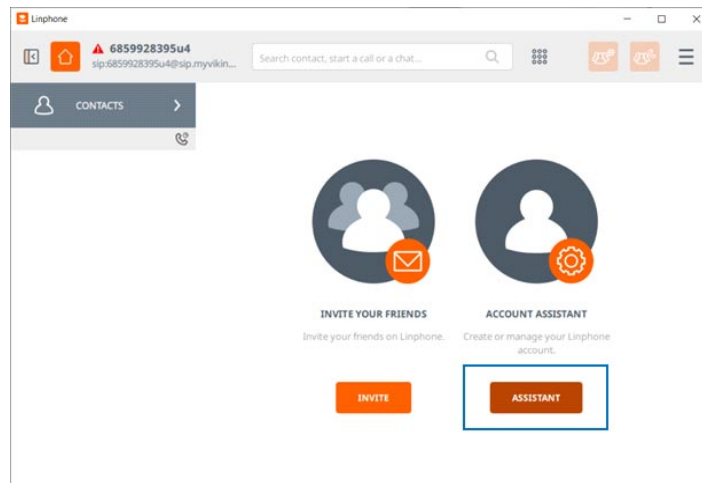

Click on 'Create a Linphone Account'. If you already have an account, click on 'Use a Linphone Account'.

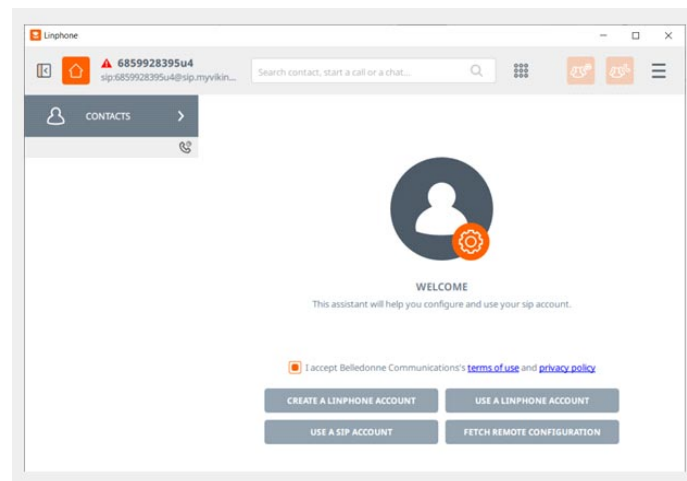

Enter your Account information and click on 'Create'. The 'Username' will be the extension the PC will use. The email address must be an email that has not had an account yet. The password will be used as the SIP password (these values are all used by Linphone to register).

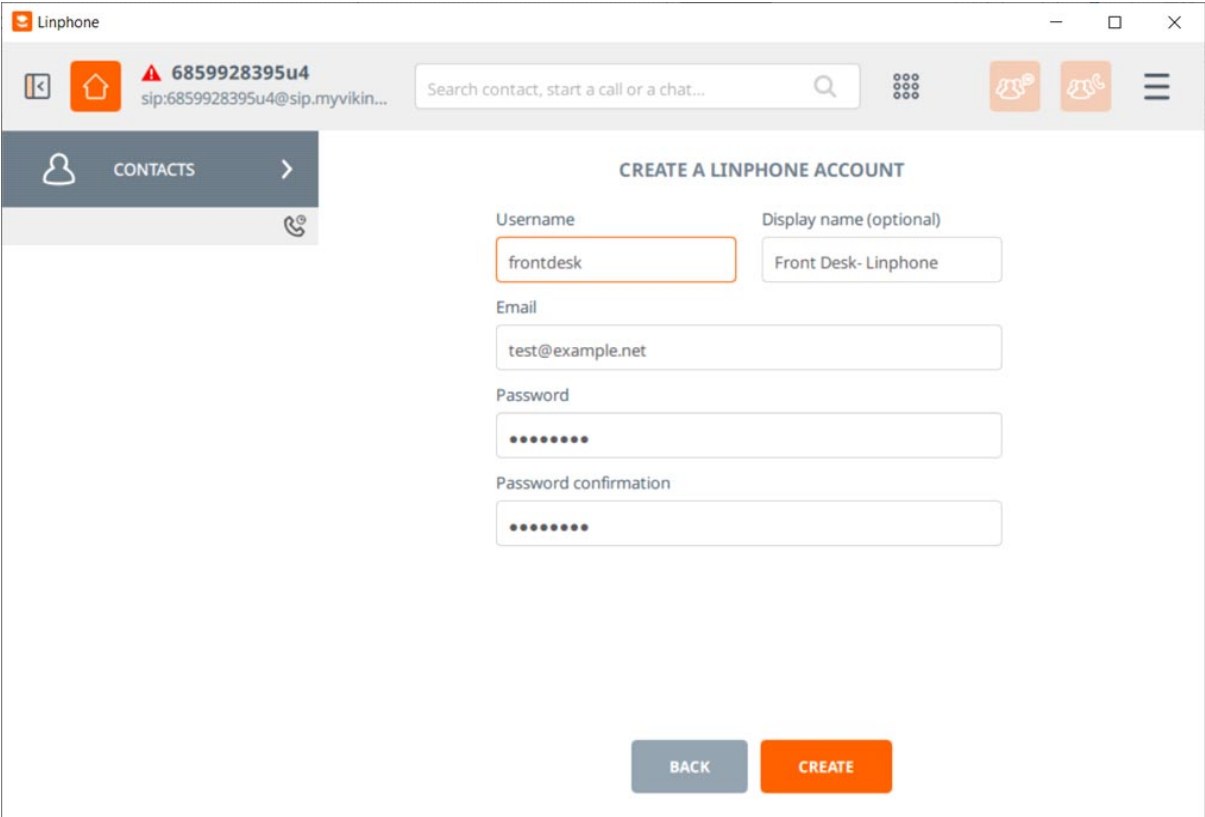

The email address will need to be verified before the account is activated.

Configuring Linphone on Android:

Download Linphone from Google Playstore. Open the app and click the '4 lines' at the top left, then click on 'Assistant'.

If you created a Linphone account online, select the 'Use a Linphone Account' option and enter the credentials.

Select the 'Create an Account' button if you want to create an account through the app (must be done with a phone number with this method).

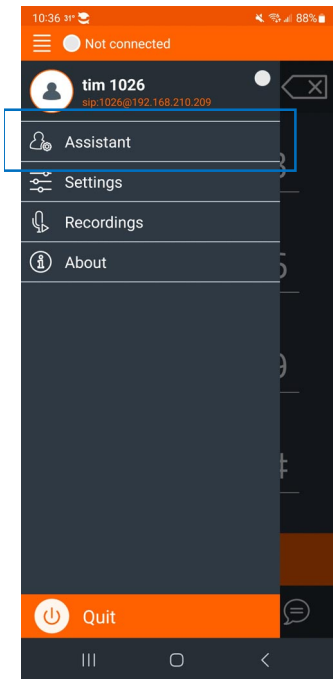

Then

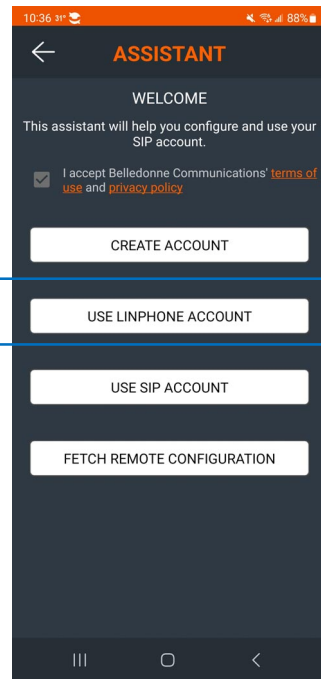

or

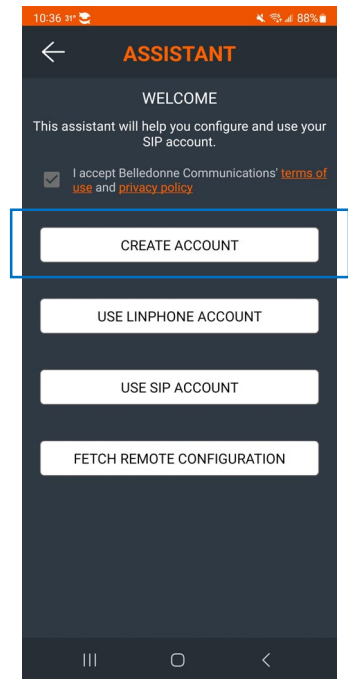

Once the Android Application is registered you will see a green dot in the upper left corner and 'Connected'.

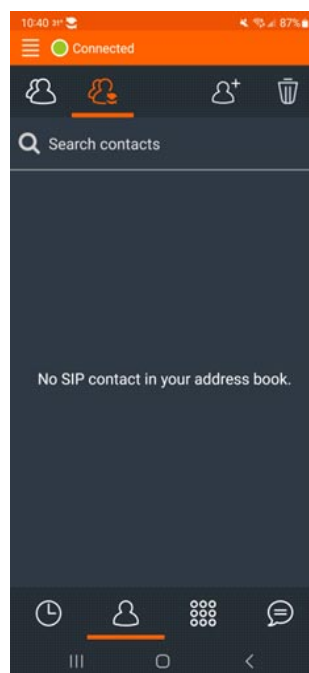

Configuring a Contact and making calls:

Click the button at the bottom the looks like a person (Contacts button). At the top click the person with a '+' symbol:

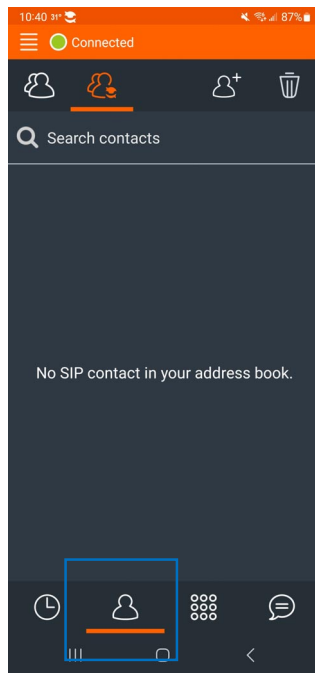

Then

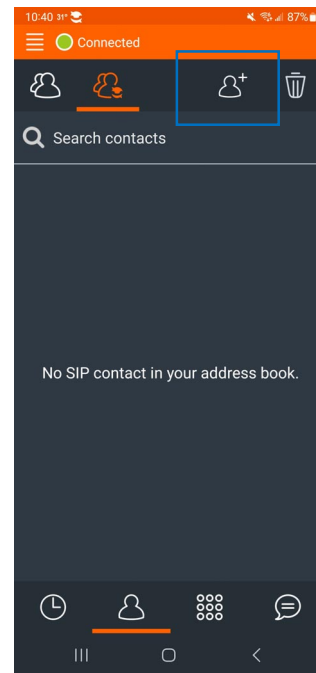

Enter a first name, last name and SIP Address. The names can be anything, but the SIP Address must be the SIP Username of the X-Series Intercom ('vikingfrontdoor' in the example above).

Remove the phone number by clicking the '-' button.

When completed click the checkmark at the upper right corner. If all credentials are valid the Contact will be saved.

Making a Call to the X-Series Intercom:

Press the Contacts name, then press the Call Button in Linphone. The X-Series Intercom should auto-answer the call with video:



Calling Linphone with the X-Series Intercom:

Configure the Speed Dial Number(s) in the X-Series Intercom:

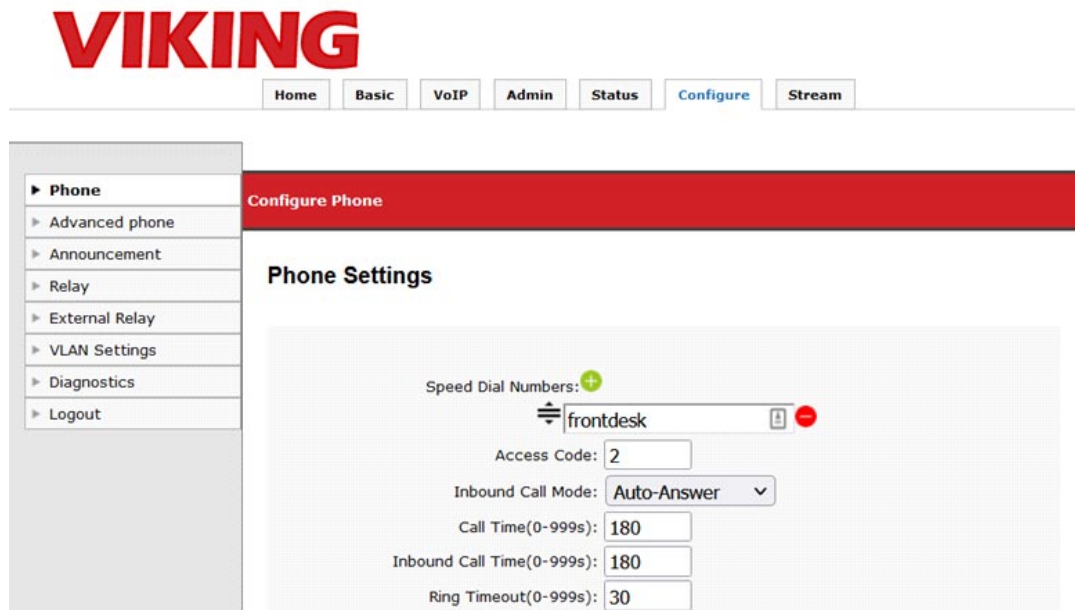

VIKING

Home Basic VoIP Admin Status **Configure** Stream

Phone

- ▶ Advanced phone
- ▶ Announcement
- ▶ Relay
- ▶ External Relay
- ▶ VLAN Settings
- ▶ Diagnostics
- ▶ Logout

Configure Phone

Phone Settings

Speed Dial Numbers:

Access Code:

Inbound Call Mode:

Call Time(0-999s):

Inbound Call Time(0-999s):

Ring Timeout(0-999s):

This is considering you have another Linphone account registered to 'frontdesk@sip.linphone.org'. When the button is pressed the X-Series Intercom will dial 'frontdesk@sip.linphone.org'.

17 - Yealink Desk Phones

Configuring Yealink phones with the X-Series Intercoms

Yealink Video desk phones can be used with Viking X-Series products using a SIP Server/Provider, or directly via 'Peer to Peer' mode.

Yealink on a SIP Server/SIP Provider:

Enter your SIP credentials under the 'Account' tab in the Yealink Web UI. Set the Account to 'Enabled' and apply/save the changes.

The screenshot shows the Yealink T58 Web UI interface for configuring SIP account settings. The 'Account' tab is selected, and the account is named 'Account 7'. The 'Register Status' is set to 'Disabled'. The 'Line Active' is set to 'Enabled'. The 'Label' is '106 Grandstream', and the 'Display Name' is also '106 Grandstream'. The 'Register Name' is '106', the 'User Name' is '106', and the 'Password' is masked with asterisks. There are two SIP servers configured: SIP Server 1 with host '192.168.210.208' and port '5060', and SIP Server 2 with an empty host and port '5060'. Both servers use 'UDP' transport, a '3600' second expiration, and '3' retry counts. The 'Enable Outbound Proxy Server' is set to 'Disabled', with two proxy servers listed, both with empty hosts and port '5060'. The 'Proxy Falback Interval' is '3600' and 'NAT' is set to 'Disabled'. A 'NOTE' section on the right explains the fields: Display Name (SIP service subscriber's name for Caller ID), Register Name (SIP service subscriber's ID for authentication), User Name (User account, provided by VoIP service provider), and NAT Traversal (Defines the STUN server will be active or not). A link to 'more guides' is provided. The interface includes a 'Log Out' button in the top right, a 'Confirm' button, and a 'Cancel' button at the bottom. Copyright © 1998-2023 **Inc. All Rights Reserved is displayed at the bottom.

If an X-Series device is registered to the same SIP Server/Provider, inbound/outbound Video calls can be made without any other changes (considering your Yealink device uses factory settings to start).

Peer to Peer calling with Yealink (or other SIP video desk phones):

A SIP server is not required to make SIP video calls, Viking X-Series devices can make and receive calls directly when they are 'Self-Registered'.

Peer to Peer is the default mode for an X-Series device. The SIP Server address is set to 127.0.0.1. The default SIP Username is 'viking'. This can be configured to any string (no spaces). See the dialing format below to configure Peer to Peer calling with a Yealink phone (using a speed dial button).

Important Configuration items in this example:

X-Series Device's IP Address: 192.168.50.246

X-Series Device's SIP Username: viking

Under the **DSS** tab, program an extension for the Yealink phone to dial. When the button on the Yealink touch screen is pressed, the desk phone will speed dial the X-Series Device.

The screenshot shows the Yealink T58 web interface with the 'DSSKey' tab selected. The 'Enable Page Tips' dropdown is set to 'Enabled'. A table lists 10 line keys. Line Key 7 is highlighted with a red box. The table has columns for Key, Type, Value, Label, Line, and Extension. The 'NOTE' section on the right contains information about Key Type, Key Event, and Intercom.

Key	Type	Value	Label	Line	Extension
Line Key1	Multicast Pagn	224.0.1.116:60000	muti	N/A	0
Line Key2	Speed Dial	16519643803	sp	Line 1	
Line Key3	Speed Dial	8799027306u1	soft	Line 1	
Line Key4	Multicast Pagn	224.0.1.75:60000	cast	N/A	0
Line Key5	Multicast Pagn	239.1.1.3:4098	testcast	N/A	0
Line Key6	Speed Dial	101	101	Line 1	
Line Key7	Speed Dial	vking@192.168.50.246	Vking	Line 1	
Line Key8	N/A			N/A	
Line Key9	N/A			N/A	
Line Key10	N/A			N/A	

NOTE

Key Type
The free function key 'Types' Speed Dial, Key Event, Intercom.

Key Event
Key events are predefined shortcuts to phone and call functions.

Intercom
Enable the 'Intercom' mode and it is useful in an office environment as a quick access to connect to the operator or the secretary.

You can click here to get more guides.

Copyright © 1998-2023 **Inc. All Rights Reserved

Peer to Peer dialing (outbound calls):

On the X-series device, set the Speed Dial number to the Yealink phone's 'Username@IPAddress' like the image below.

Important Configuration items in this example:

Yealink Phone's IP Address: 192.168.50.17

Yealink Phone's SIP Username: 106

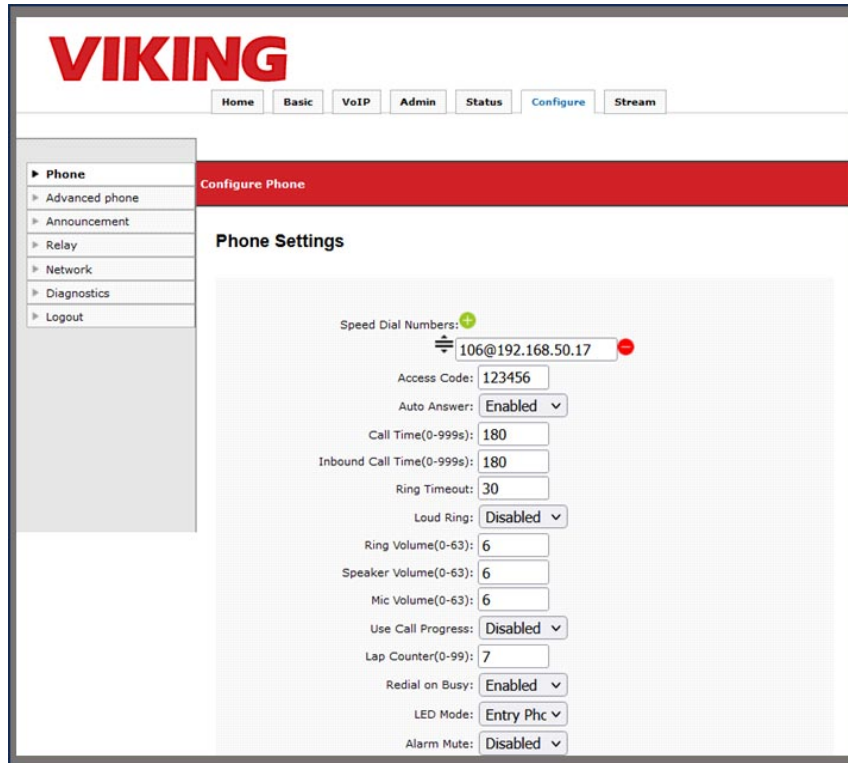

The screenshot displays the VIKING web interface for configuring a phone. The top navigation bar includes 'Home', 'Basic', 'VoIP', 'Admin', 'Status', 'Configure', and 'Stream'. The left sidebar shows a menu with 'Phone' selected, and sub-items: 'Advanced phone', 'Announcement', 'Relay', 'Network', 'Diagnostics', and 'Logout'. The main content area is titled 'Configure Phone' and 'Phone Settings'. The 'Speed Dial Numbers' section shows a list with one entry: '106@192.168.50.17'. Below this, various settings are configured:

Speed Dial Numbers:	106@192.168.50.17
Access Code:	123456
Auto Answer:	Enabled
Call Time(0-999s):	180
Inbound Call Time(0-999s):	180
Ring Timeout:	30
Loud Ring:	Disabled
Ring Volume(0-63):	6
Speaker Volume(0-63):	6
Mic Volume(0-63):	6
Use Call Progress:	Disabled
Lap Counter(0-99):	7
Redial on Busy:	Enabled
LED Mode:	Entry Phc
Alarm Mute:	Disabled

A. SIP / Network Alarm

If there is a network error or the unit cannot register to the SIP Server/Provider the blue LED on the button will blink on and off every 2 seconds, and three error beeps will be heard every 30 seconds until the problem is resolved. This is to alert users to a potential problem that may prevent the X-Series device from making an outbound call.

B. Muting the SIP / Network Alarm

These beeps can be temporarily or permanently disabled. To mute the Alarm press and hold the button for at least 5 seconds (2 beeps will be heard indicating when to release it). This mutes the beeps until the next reboot, power cycle, or a change in registration/network status. The beeps can be permanently disabled on the Configure Tab under “Phone Settings”. Set the Alarm Mute setting to “Disabled” and the beeps will be disabled for all “Alarm” conditions. The LED will continue flash when the unit’s “Alarm” is active even if the beeps are muted.

19 - Open Source Licenses

Our X-Series firmware contains code from open-source packages which have been published under various licenses.

PACKAGE-VERSION	LICENSE TYPE	CHANGED	X-SERIES (BETA)	X-SERIES (V1.0)
curl v7.69.1-DEV	MIT-curl		x	
ffmpeg	LGPL 2.1		x	
glib v2.0	LGPL 2.1		x	
gSOAP v2.8	LGPL v2	x	x	
GStreamer v1.20	LPGL		x	
Kernel v4.9.88	GPL		x	
libatopology	LGPL 2.1+		x	
libfdk aac	GPL		x	
libffi	MIT-GNU-GPL		x	
libgcrypt	LGPL 2.1+		x	
libgmp v6.1	LGPL 2/3		x	
libgnuutils	LGPL 2.1+		x	
libgpg-error	LGPL 2.1		x	
libhogweed v6.0	LGPL 2		x	
libjpeg v62.2.0	jpeg license		x	
libjson-glib v1.0	LGPL 2.1		x	
libmicrodns v0.1.0			x	
libmp3lame v0.0	LPGL		x	
libnettle v8.0-nettle_3.6	LGPL 2+/3		x	
libnice v10.9	LGPL 2.1		x	
libpcrc-16	BSD		x	
libpcrc-32	BSD		x	
libpcrcposix v0.0.7	BSD		x	
libturbojpeg v0.1	BSD		x	
libvpu v.4	LGPL 2.1		x	
libxml2 v2.9.12	MIT		x	
OpenSSL v1.0.2u	OpenSSL		x	
U-Boot v	GPL v2	x	x	
zlib v.1.2.11	GPL		x	

libjpeg license:

LICENSE TERMS (ships as a part of the libjpeg package in the README file)

=====

1. We don't promise that this software works. (But if you find any bugs, please let us know!)
2. You can use this software for whatever you want. You don't have to pay us.
3. You may not pretend that you wrote this software. If you use it in a program, you must acknowledge somewhere in your documentation that you've used the IJG code.

In legalese:

The authors make NO WARRANTY or representation, either express or implied, with respect to this software, its quality, accuracy, merchantability, or fitness for a particular purpose. This software is provided "AS IS", and you, its user, assume the entire risk as to its quality and accuracy.

This software is copyright (C) 1991-2016, Thomas G. Lane, Guido Vollbeding. All Rights Reserved except as specified below.

Permission is hereby granted to use, copy, modify, and distribute this software (or portions thereof) for any purpose, without fee, subject to these conditions:

- (1) If any part of the source code for this software is distributed, then this README file must be included, with this copyright and no-warranty notice unaltered; and any additions, deletions, or changes to the original files must be clearly indicated in accompanying documentation.
- (2) If only executable code is distributed, then the accompanying documentation must state that "this software is based in part on the work of the Independent JPEG Group".
- (3) Permission for use of this software is granted only if the user accepts full responsibility for any undesirable consequences; the authors accept NO LIABILITY for damages of any kind.

These conditions apply to any software derived from or based on the IJG code, not just to the unmodified library. If you use our work, you ought to acknowledge us.

Permission is NOT granted for the use of any IJG author's name or company name in advertising or publicity relating to this software or products derived from it. This software may be referred to only as "the Independent JPEG Group's software".

We specifically permit and encourage the use of this software as the basis of commercial products, provided that all warranty or liability claims are assumed by the product vendor.

Curl license:

COPYRIGHT AND PERMISSION NOTICE

Copyright (c) 1996 - 2022, Daniel Stenberg, daniel@haxx.se, and many contributors, see the THANKS file.

All rights reserved.

Permission to use, copy, modify, and distribute this software for any purpose with or without fee is hereby granted, provided that the above copyright notice and this permission notice appear in all copies.

THE SOFTWARE IS PROVIDED "AS IS", WITHOUT WARRANTY OF ANY KIND, EXPRESS OR IMPLIED, INCLUDING BUT NOT LIMITED TO THE WARRANTIES OF MERCHANTABILITY, FITNESS FOR A PARTICULAR PURPOSE AND NONINFRINGEMENT OF THIRD PARTY RIGHTS. IN NO EVENT SHALL THE AUTHORS OR COPYRIGHT HOLDERS BE LIABLE FOR ANY CLAIM, DAMAGES OR OTHER LIABILITY, WHETHER IN AN ACTION OF CONTRACT, TORT OR OTHERWISE, ARISING FROM, OUT OF OR IN CONNECTION WITH THE SOFTWARE OR THE USE OR OTHER DEALINGS IN THE SOFTWARE.

Except as contained in this notice, the name of a copyright holder shall not be used in advertising or otherwise to promote the sale, use or other dealings in this Software without prior written authorization of the copyright holder.

OpenSSL: dual OpenSSL and SSLeay license:

OpenSSL License

=====

Copyright (c) 1998-2019 The OpenSSL Project. All rights reserved.

Redistribution and use in source and binary forms, with or without modification, are permitted provided that the following conditions are met:

1. Redistributions of source code must retain the above copyright notice, this list of conditions and the following disclaimer.
2. Redistributions in binary form must reproduce the above copyright notice, this list of conditions and the following disclaimer in the documentation and/or other materials provided with the distribution.
3. All advertising materials mentioning features or use of this software must display the following acknowledgment:
"This product includes software developed by the OpenSSL Project for use in the OpenSSL Toolkit. (<http://www.openssl.org/>)"
4. The names "OpenSSL Toolkit" and "OpenSSL Project" must not be used to endorse or promote products derived from this software without prior written permission. For written permission, please contact openssl-core@openssl.org.
5. Products derived from this software may not be called "OpenSSL" nor may "OpenSSL" appear in their names without prior written permission of the OpenSSL Project.
6. Redistributions of any form whatsoever must retain the following acknowledgment:
"This product includes software developed by the OpenSSL Project for use in the OpenSSL Toolkit (<http://www.openssl.org/>)"

THIS SOFTWARE IS PROVIDED BY THE OpenSSL PROJECT "AS IS" AND ANY EXPRESSED OR IMPLIED WARRANTIES, INCLUDING, BUT NOT LIMITED TO, THE IMPLIED WARRANTIES OF MERCHANTABILITY AND FITNESS FOR A PARTICULAR PURPOSE ARE DISCLAIMED. IN NO EVENT SHALL THE OpenSSL PROJECT OR ITS CONTRIBUTORS BE LIABLE FOR ANY DIRECT, INDIRECT, INCIDENTAL, SPECIAL, EXEMPLARY, OR CONSEQUENTIAL DAMAGES (INCLUDING, BUT NOT LIMITED TO, PROCUREMENT OF SUBSTITUTE GOODS OR SERVICES; LOSS OF USE, DATA, OR PROFITS; OR BUSINESS INTERRUPTION) HOWEVER CAUSED AND ON ANY THEORY OF LIABILITY, WHETHER IN CONTRACT, STRICT LIABILITY, OR TORT (INCLUDING NEGLIGENCE OR OTHERWISE) ARISING IN ANY WAY OUT OF THE USE OF THIS SOFTWARE, EVEN IF ADVISED OF THE POSSIBILITY OF SUCH DAMAGE.

=====

This product includes cryptographic software written by Eric Young (ey@cryptsoft.com).
This product includes software written by Tim Hudson (tjh@cryptsoft.com)

Original SSLeay License

Copyright (C) 1995-1998 Eric Young (eay@cryptsoft.com)
All rights reserved.

This package is an SSL implementation written by Eric Young (eay@cryptsoft.com).
The implementation was written so as to conform with Netscapes SSL.

This library is free for commercial and non-commercial use as long as the following conditions are adhered to. The following conditions apply to all code found in this distribution, be it the RC4, RSA, lhash, DES, etc., code; not just the SSL code. The SSL documentation included with this distribution is covered by the same copyright terms except that the holder is Tim Hudson (tjh@cryptsoft.com)

Copyright remains Eric Young's, and as such any Copyright notices in the code are not to be removed.
If this package is used in a product, Eric Young should be given attribution as the author of the parts of the library used.
This can be in the form of a textual message at program startup or in documentation (online or textual) provided with the package.

Redistribution and use in source and binary forms, with or without modification, are permitted provided that the following conditions are met:

1. Redistributions of source code must retain the copyright notice, this list of conditions and the following disclaimer.
2. Redistributions in binary form must reproduce the above copyright notice, this list of conditions and the following disclaimer in the documentation and/or other materials provided with the distribution.
3. All advertising materials mentioning features or use of this software must display the following acknowledgement:
"This product includes cryptographic software written by Eric Young (eay@cryptsoft.com)" The word 'cryptographic' can be left out if the routines from the library being used are not cryptographic related :-).
4. If you include any Windows specific code (or a derivative thereof) from the apps directory (application code) you must include an acknowledgement: "This product includes software written by Tim Hudson (tjh@cryptsoft.com)"

THIS SOFTWARE IS PROVIDED BY ERIC YOUNG ``AS IS" AND ANY EXPRESS OR IMPLIED WARRANTIES, INCLUDING, BUT NOT LIMITED TO, THE IMPLIED WARRANTIES OF MERCHANTABILITY AND FITNESS FOR A PARTICULAR PURPOSE ARE DISCLAIMED. IN NO EVENT SHALL THE AUTHOR OR CONTRIBUTORS BE LIABLE FOR ANY DIRECT, INDIRECT, INCIDENTAL, SPECIAL, EXEMPLARY, OR CONSEQUENTIAL DAMAGES (INCLUDING, BUT NOT LIMITED TO, PROCUREMENT OF SUBSTITUTE GOODS OR SERVICES; LOSS OF USE, DATA, OR PROFITS; OR BUSINESS INTERRUPTION) HOWEVER CAUSED AND ON ANY THEORY OF LIABILITY, WHETHER IN CONTRACT, STRICT LIABILITY, OR TORT (INCLUDING NEGLIGENCE OR OTHERWISE) ARISING IN ANY WAY OUT OF THE USE OF THIS SOFTWARE, EVEN IF ADVISED OF THE POSSIBILITY OF SUCH DAMAGE.

The licence and distribution terms for any publically available version or derivative of this code cannot be changed. i.e. this code cannot simply be copied and put under another distribution licence [including the GNU Public Licence.]

Warranty

IF YOU HAVE A PROBLEM WITH A VIKING PRODUCT, CONTACT VIKING TECHNICAL SUPPORT: 715-386-8666

Our Technical Support Department is available for assistance Monday through Friday 8:00am to 5:00pm central time. Before you call, please:

1. Know the model number, the serial number and what software version you have (see serial label).
2. Have the Product Manual in front of you.
3. It is best if you are on site.

RETURNING PRODUCT FOR REPAIR

The following procedure is for equipment that needs repair:

1. Customer must contact Viking's Technical Support Department at 715-386-8666 to obtain a Return Authorization (RA) number. The customer MUST have a complete description of the problem, with all pertinent information regarding the defect, such as options set, conditions, symptoms, methods to duplicate problem, frequency of failure, etc.
2. Packing: Return equipment in original box or in proper packing so that damage will not occur while in transit. The original product boxes are not designed for shipping - an overpack box is required to prevent damage in transit. Static sensitive equipment such as a circuit board should be in an anti-static bag, sandwiched between foam and individually boxed. All equipment should be wrapped to avoid packing material lodging in or sticking to the equipment. Include ALL parts of the equipment. C.O.D. or freight collect shipments cannot be accepted. Ship cartons prepaid to: **VIKING ELECTRONICS
1531 INDUSTRIAL STREET
HUDSON, WI 54016**
3. Return shipping address: Be sure to include your return shipping address inside the box. We cannot ship to a PO Box.
4. RA number on carton: In large printing, write the RA number on the outside of each carton being returned.

RETURNING PRODUCT FOR EXCHANGE

The following procedure is for equipment that has failed out-of-box (within 10 days of purchase):

1. Customer must contact Viking's Technical Support at 715-386-8666 to determine possible causes for the problem. The customer MUST be able to step through recommended tests for diagnosis.
2. If the Technical Support Product Specialist determines that the equipment is defective based on the customer's input and troubleshooting, a Return Authorization (RA) number will be issued. This number is valid for fourteen (14) calendar days from the date of issue.
3. After obtaining the RA number, return the approved equipment to your distributor. Please reference the RA number on the paperwork being shipped back with the unit(s), and also the outside of the shipping box. The original product boxes are not designed for shipping - an overpack box is required to prevent damage in transit. Once your distributor receives the package, they will replace the product over the counter at no charge. The distributor will then return the product to Viking using the same RA number.
4. **The distributor will NOT exchange this product without first obtaining the RA number from you. If you haven't followed the steps listed in 1, 2 and 3, be aware that you will have to pay a restocking charge.**

TWO YEAR LIMITED WARRANTY

Viking warrants its products to be free from defects in the workmanship or materials, under normal use and service, for a period of two years from the date of purchase from any authorized Viking distributor. If at any time during the warranty period, the product is deemed defective or malfunctions, return the product to Viking Electronics, Inc., 1531 Industrial Street, Hudson, WI., 54016. Customer must contact Viking's Technical Support Department at 715-386-8666 to obtain a Return Authorization (R.A.) number.

This warranty does not cover any damage to the product due to lightning, over voltage, under age, accident, misuse, abuse, negligence or any damage caused by use of the product by the purchaser or others. This warranty does not cover non-EWP products that have been exposed to wet or corrosive environments. This warranty does not cover stainless steel surfaces that have not been properly maintained.

NO OTHER WARRANTIES. VIKING MAKES NO WARRANTIES RELATING TO ITS PRODUCTS OTHER THAN AS DESCRIBED ABOVE AND DISCLAIMS ANY EXPRESS OR IMPLIED WARRANTIES OR MERCHANTABILITY OR FITNESS FOR ANY PARTICULAR PURPOSE.

EXCLUSION OF CONSEQUENTIAL DAMAGES. VIKING SHALL NOT, UNDER ANY CIRCUMSTANCES, BE LIABLE TO PURCHASER, OR ANY OTHER PARTY, FOR CONSEQUENTIAL, INCIDENTAL, SPECIAL OR EXEMPLARY DAMAGES ARISING OUT OF OR RELATED TO THE SALE OR USE OF THE PRODUCT SOLD HEREUNDER.

EXCLUSIVE REMEDY AND LIMITATION OF LIABILITY. WHETHER IN AN ACTION BASED ON CONTRACT, TORT (INCLUDING NEGLIGENCE OR STRICT LIABILITY) OR ANY OTHER LEGAL THEORY, ANY LIABILITY OF VIKING SHALL BE LIMITED TO REPAIR OR REPLACEMENT OF THE PRODUCT, OR AT VIKING'S OPTION, REFUND OF THE PURCHASE PRICE AS THE EXCLUSIVE REMEDY AND ANY LIABILITY OF VIKING SHALL BE SO LIMITED.

IT IS EXPRESSLY UNDERSTOOD AND AGREED THAT EACH AND EVERY PROVISION OF THIS AGREEMENT WHICH PROVIDES FOR DISCLAIMER OF WARRANTIES, EXCLUSION OF CONSEQUENTIAL DAMAGES, AND EXCLUSIVE REMEDY AND LIMITATION OF LIABILITY, ARE SEVERABLE FROM ANY OTHER PROVISION AND EACH PROVISION IS A SEPARABLE AND INDEPENDENT ELEMENT OF RISK ALLOCATION AND IS INTENDED TO BE ENFORCED AS SUCH.

If trouble is experienced with the **X-205**, for repair or warranty information, please contact:

Viking Electronics, Inc., 1531 Industrial Street, Hudson, WI 54016 Phone: 715-386-8666

WHEN PROGRAMMING EMERGENCY NUMBERS AND (OR) MAKING TEST CALLS TO EMERGENCY NUMBERS:

Remain on the line and briefly explain to the dispatcher the reason for the call. Perform such tests in off-peak hours, such as early morning or late evenings.

PART 15 LIMITATIONS

This equipment has been tested and found to comply with the limits for a Class A digital device, pursuant to Part 15 of the FCC Rules. These limits are designed to provide reasonable protection against harmful interference when the equipment is operated in a commercial environment. This equipment generates, uses, and can radiate radio frequency energy and, if not installed and used in accordance with the instruction manual, may cause harmful interference to radio communications. Operation of this equipment in a residential area is likely to cause harmful interference in which case the user will be required to correct the interference at his own expense.

CANADA

This class A digital apparatus complies with Canadian ICES-003. Cet appareil numérique de la classe A est conforme a la norme NMB-003 du Canada.

Product Support: 715-386-8666

Due to the dynamic nature of the product design, the information contained in this document is subject to change without notice. Viking Electronics, and its affiliates and/or subsidiaries assume no responsibility for errors and omissions contained in this information. Revisions of this document or new editions of it may be issued to incorporate such changes.